

Lift and Dispense Heavy Drum

- Frame made of Bead Blast Finish Type 304 Stainless Steel
- Control Lift Height and Pouring Angle
- Remove Effort and Increase Productivity
- Power Lift and Tilt Models
- 360° Tilt Control in Either Direction
- Capacity
 - 800 Lb. (363 kg) full drum
 - 500 Lb. (227 kg) half-full* drum

Easily handle a heavy drum with Morse Hydra-Lift Karriers. Lift, move and control pouring of 55-gallon (210 liter) drum weighing up to 800 Lb. (363 kg) with minimal effort. Models with maximum pouring heights of 72" or 96" (183 or 244 cm).

Increase pouring angle for full discharge, reduce to control pour rate or reverse to stop pouring and deliver partial drum contents. Material pours forward from drum. Works with faucet, pipe, valve extension, etc. attached to drum.

Though most often used to lift and pour a drum, Hydra-Lift Karriers can also be used to lift a drum on and off scales, platforms, conveyors or trucks, move drums to or from storage, or position drums of parts for hand access at work stations.

Handle a variety of drums by installing the correct accessories for your drum.



Each Hydra-Lift Karrier Features

Heavy-duty hydraulic ram has built-in flow control for uniform, controlled speed of descent even with heaviest drum. Velocity fuse provides full line shut-off in event of line failure.

Easily maneuver: Two front 8" (20.3 cm) durable polyolefin wheels and two 4" (10.2 cm) rear swivel casters hidden under base. Step-down floor lock helps hold Hydra-Lift Karrier in place while you dispense drum.

Manual-Lift models have hydraulic hand pump for drum lift.

Manual-Tilt models have covered tilt gears with 30:1 reduction for simple and easy drum pouring.

Frame made of bead blast finished type 304 stainless steel. Welds are NOT ground smooth or polished. Ratchet and pawl on drum holder are NOT stainless steel, but are coated with FDA compliant powder coat. Gears, sprockets and chain are NOT stainless steel, but are covered with guards.

Factory Installed OPTIONS

- Option SSG-PT Stainless gears on power tilt model
- Option SSG-MT Stainless gears on manual tilt model
- Option 5597SSi-P Stainless steel ratchet and pawl

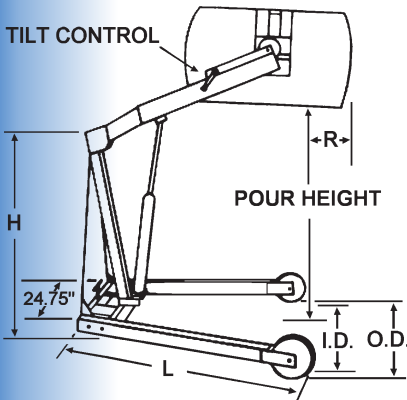

Model	Max. Pouring Height	R	H	L	O.D.	I.D.	Turning Radius	Domestic Ship Weight
400A-72SS	72" (1.83 m)	6" (15 cm)	55" (140 cm)	60" (152 cm)	44" (112 cm)	37" (94 cm)	6'	350 Lb. (159 kg)
400A-96SS	96" (2.44 m)	-3" (-7.6 cm)	69" (175 cm)	72.5" (184 cm)	49" (124 cm)	42" (107 cm)	7'	379 Lb. (172 kg)



Drum Handling System

MORCINCH Drum Holder

- Automatically adjusts for 22" to 23.5" (56 to 59.7 cm) diameter drum
- Accepts Diameter Adapters for smaller drums
- Install Top Rim Clamp or Bracket for plastic or fiber drum
- Flexible cinch chain cover helps protect drum sidewall
- Durable stress relief weld joints



Manual Tilt Models have pull chain and chain wheel tilt control

Manual Tilt Control Options
We recommend **MORStop Tilt-Brake Option 3900SSi-P** to automatically hold drum tilt angle

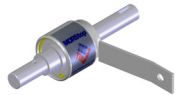

9" (22.9 cm) Hand Crank
Option X02-400-72SS or X02-400-96SS



16" (40.6 cm) Hand Wheel
Option X03-400-72SS or X03-400-96SS



* Half-full rating is based on tilt mechanism's capacity for handling bottom heavy drum. Partially full drum with unbalanced, shifting load is harder to tilt than full drum.

Reach Beyond Front Wheels with 55-Gallon (210L) Steel Drum			
Model	Dispensing Height	Reach with Horizontal Drum	Reach with Drum Pouring at 45 Degrees
400A-72SS	36" (91.4 cm)	16" (40.6 cm)	2" (5.1 cm)
	48" (121.9 cm)	15" (38.1 cm)	0
	60" (152.4 cm)	12" (30.5 cm)	-7" (-17.8 cm)
	72" (182.9 cm)	6" (15.2 cm)	- N/A -
400A-96SS	36" (91.4 cm)	11" (27.9 cm)	-1" (-2.5 cm)
	48" (121.9 cm)	13" (33 cm)	0
	60" (152.4 cm)	13" (33 cm)	-3" (-7.6 cm)
	72" (182.9 cm)	11" (27.9 cm)	-7" (-17.8 cm)
	84" (213.4 cm)	6" (15.2 cm)	-15" (-38.1 cm)
	96" (243.8 cm)	-3" (-7.6 cm)	-20" (-50.8 cm) at 90° (228.6 cm)



morsedrum.com



service@morsedrum.com



(315) 437-8475



103 Kuhn Rd.
Syracuse, NY, 13208 USA

Power-Lift and Tilt Models

Easier and faster drum handling.

Two hand valve controls: One for power-lift function and second for power-tilt.

Power Suffix	Motor Type	Motor Control	Ship Weight Adder
-110	AC, 1HP/115V, TEFC	Switch, Cord, Plug	75 Lb. (34 kg)
-114	Air, Vane Type	On/Off Valve	95 Lb. (43 kg)
-115	DC, 12V	4 Button Pendant	120 Lb. (54 kg)

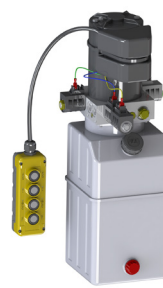
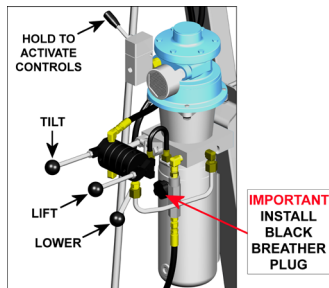
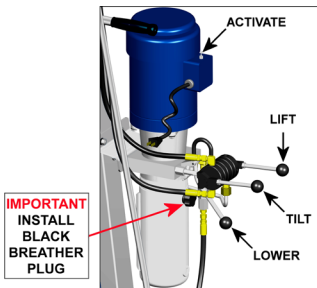

Electric Power Lift and Tilt

Raise drum: Hold momentary switch and raise lift valve.

Tilt drum: Hold momentary switch and raise tilt valve.

Lower drum: Use manual release valve.

Air Power Lift and Tilt

Raise drum: Hold on/off air valve and raise lift valve.

Tilt drum: Hold on/off valve and raise tilt valve.

Lower drum: Use manual release valve.

Requires: 40 to 60 PSI at 40 SCFM.

Battery Power Lift and Tilt

Raise, Tilt and Lower drum: Operate push button controls on pendant.

Self contained battery power lift and tilt. Separate charger is included.

Power-Lift, Manual Tilt Models

Ease drum lifting, but retain manual tilt control with pull chain tilt control.

Power Suffix	Motor Type	Motor Control	Ship Weight Adder
-120	AC, 1HP/115V, TEFC	Switch, Cord, Plug	40 Lb. (18 kg)
-124	Air, Vane Type	On/Off Valve	25 Lb. (11 kg)
-125	DC, 12V	2 Button Pendant	85 Lb. (39 kg)

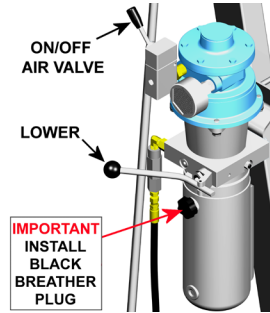
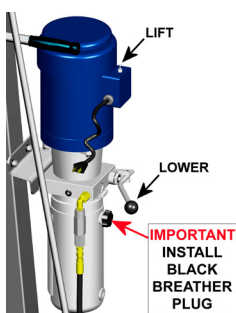

Electric Power Lift

Raise drum: Hold momentary switch.

Tilt drum: Use pull chain, hand crank or hand wheel.

Lower drum: Use manual release valve.

Air Motor Power Lift

Raise drum: Hold on/off air valve and lift valve.

Tilt drum: Use pull chain, hand crank or hand wheel.

Lower drum: Use manual release valve.

Requires: 40 to 60 PSI at 40 SCFM.

Battery Power Lift

Raise and Lower drum: Operate push button controls on pendant.

Tilt drum: Use pull chain, hand crank or hand wheel.

Self contained battery power lift and tilt. Separate charger is included.

NOTE: 12V Deep Cycle Lead Acid Battery is designed for domestic shipment only. For export shipment, choose Option "NB" (No Battery). Customer must obtain battery before use... Exide 27MDP 12V Deep Cycle Battery or equivalent.

Accessories

MORCINCH Drum Holder is designed to handle 55-gallon (210 liter) steel drum. Automatically adjusts from 22" to 23.5" (56 to 59.7 cm) diameter. Cinch chain with pawl and ratchet secures drum in holder.

To prevent PLASTIC or FIBER drum from slipping length-ways, permanently install ONLY ONE of the following two kits:

Kit 4560BSS-P Top Rim Clamp
ONLY for RIMMED 30 to 55-gallon (114 to 210 liter) size plastic or fiber drum.

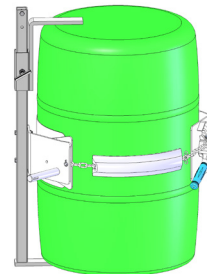
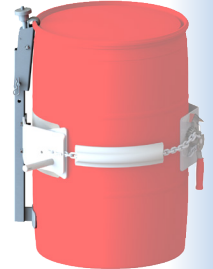

Kit 4566SS-P Bracket Assembly
For RIMLESS or RIMMED 30 to 55-gallon (114 to 210 liter) plastic drum, or more securely hold a fiber drum. Adjusts for 31" to 39" (79 to 99 cm) tall drum.

For smaller drum

55/30SS Series Diameter Adapters
Insert correct diameter adapter for each smaller size drum. Adapters simply fit inside MORCINCH drum holder without tools and are quickly removed.

Adapters for 17.5" (44.5 cm) diameter or smaller have integrated brackets at top and bottom of the drum. The brackets adjust for a drum up to 38" (96.5 cm) tall.

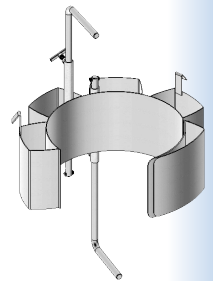

Diameter Adapter Model 55/30SS-16

Stainless Steel Diameter Adapters		
Model Number	Fits Diameter	Integrated Brackets
55/30SS-20.5	20" to 20.5" (50.8 to 52.1 cm)	No
55/30SS-19	18.5" to 19" (47 to 48.3 cm)	No
55/30SS-19B	18.5" to 19" (47 to 48.3 cm)	Yes
55/30SS-17.5	17" to 17.5" (43.2 to 44.5 cm)	Yes
55/30SS-16	15.5" to 16" (39.4 to 40.6 cm)	Yes
55/30SS-14.5	14" to 14.5" (35.6 to 36.8 cm)	Yes

Web Strap and Stainless Steel Ratchet

Replaces standard cinch chain to secure around drum.

- **Option 5115SSI-P** Factory installed Option on new drum handler.
- **Kit 5115SS-P** For customer to install on existing drum handler.

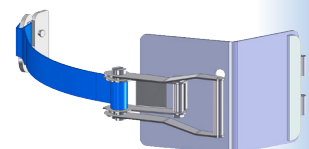



Model 400A-72SS-120 72" (1.83 m) dispensing height, electric power lift, and manual drum tilt.

Shown with Hand Crank **Option X02-400-72SS**



Model 400A-72SS-125 Raise drum with ergonomic battery power drum lift. Choose model with Battery, plug-in electric or AIR power drum lift and tilt.



Turn drum 360° in either direction with pull chain and chain wheel. Choose model with Battery, plug-in electric or AIR power drum lift and tilt.

MADE
IN
USA

Model Numbers							
Maximum Pour Height	AC Motor *** Power Lift and Tilt	Air Motor † Power Lift & Tilt	12V DC ** Power Lift & Tilt	AC Motor *** Power Lift, Manual Tilt *	Air Motor † Power Lift, Manual Tilt *	12V DC ** Power Lift, Manual Tilt *	Manual Lift & Manual Tilt *
72"	400A-72SS-110	400A-72SS-114	400A-72SS-115	400A-72SS-120	400A-72SS-124	400A-72SS-125	400A-72SS
96"	400A-96SS-110	400A-96SS-114	400A-96SS-115	400A-96SS-120	400A-96SS-124	400A-96SS-125	400A-96SS

* Manual tilt control is chain wheel and pull-chain.

** 12V DC power option includes battery and 110V AC charger.

*** Standard AC motors are 1HP, 115V, 60 Hz, TEFC. Explosion-proof motors and 50Hz motors are also available.

† Air motor Requirements: 40 to 60 PSI at 40 SCFM

Accessories for Customer to Install

Kit	Description
4560BSS-P	Stainless Steel Top Rim Clamp for rimmed 55-gallon plastic drum
4556SS-P	Stainless Steel Bracket Assembly required for rimless 55-gallon plastic drum
55/30SS Series	Stainless Steel Diameter Adapters for various sizes of smaller drum

Factory Installed Options

Option	Description
5115SSi-P	Web Strap and Stainless Steel Ratchet
3900SSi-P	MORStop Tilt-Brake for MANUAL-TILT model
X02-400-72SS	9" Hand Crank for 72" MANUAL-TILT model
X02-400-96SS	9" Hand Crank for 96" MANUAL-TILT model
X03-400-72SS	16" Hand Wheel for 72" MANUAL-TILT model
X03-400-96SS	16" Hand Wheel for 96" MANUAL-TILT model
SSG-PT	Stainless Steel Gears and Sprockets on POWER-TILT Hydra-Lift
SSG-MT	Stainless Steel Gears and Sprockets on MANUAL-TILT Hydra-Lift
5597SSi-P	Stainless Steel Ratchet and Pawl
FGO	Food Grade Hydraulic Oil