

CONTENTS

- **Receiving Procedures**
- **Warranty**
- **Safety Information**
- **Machine Description**
- **Options**
- **Assembly and Installation Instructions**
- **Operating Instructions**
- **Maintenance**

Receiving Procedures

Every Morse drum handler is inspected prior to shipping. However, damage may be incurred during transit.

- Check for visible damage. If you choose to accept damaged freight, always sign noting the damage on the **BILL OF LADING**.
- Document the damage and have the truck driver sign. We recommend keeping a digital camera at your receiving dock for this purpose.
- Open packages expeditiously to check the condition of the goods. There is only a 24 hour window to notify the carrier of any concealed damage.
- **IMMEDIATELY REPORT ALL DAMAGE TO THE SHIPPING COMPANY!** Then you may contact Morse for assistance with your freight claim.
- Morse Manufacturing will not be held responsible for any damaged freight that is not signed for as damaged.

Delivery to non-business addresses without a loading dock result in additional freight charges. Residential delivery fees, inside delivery fees, re-delivery charges, and lift gate services will be added by the truck line, and are non-negotiable.

Limited 2 Year Warranty

Morse drum handling equipment is guaranteed against defects in workmanship or materials for **TWO YEARS** when used properly within its rated capacity. Warranty does not cover wear from normal use or damage from accident or abuse. Motors and other purchased parts carry the warranties of their manufacturers.

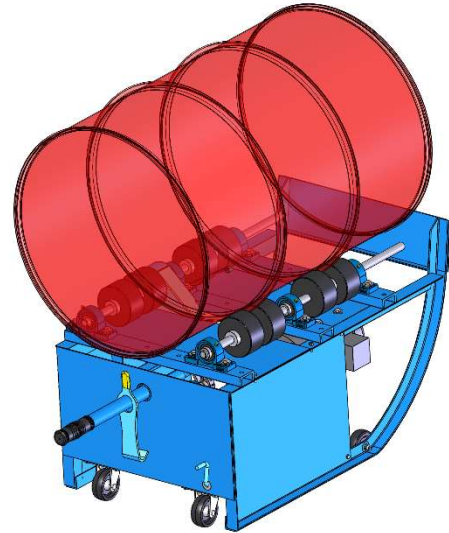

For warranty claims, contact your Morse Dealer to obtain a return authorization number, and for return freight advice. Return freight must be prepaid.

In all instances, liability is limited to the purchase price paid or to repairing or replacing the product. Customer assumes liability for any modifications, unauthorized repairs or parts substitution.

Safety Information

While Morse Manufacturing Co. drum handling equipment is engineered for safety and efficiency, a high degree of responsibility must be placed upon the machine operator to follow safe practices, based primarily on common sense, upon which true safety depends.

Failure to follow the safety precautions in this manual can result in personal injury or property damage. Observe the same precautions as with similar machinery where carelessness in operating or maintenance is hazardous to personnel. Carefully read the safety precautions below and throughout this manual.

Review the Material Safety Data Sheet(s) for the material(s) in the drum(s) and take all necessary precautions. Safety shoes, work gloves, hard hat and other personal protective devices are recommended.

Prior to initial use, inspect all moving parts and test rotation of wheels. Perform necessary inspections, operator training, etc.











DANGER - Indicates a situation which, if not avoided, *will* result in serious injury or death. This signal word is limited to the most extreme situations.



WARNING - Indicates a situation which, if not avoided, *could* result in serious injury or death.



CAUTION - Indicates a situation which, if not avoided, can result in damage to the machine.

		<p>DANGER - Stay Clear of Rotating Drum. NEVER allow anyone to be near any part of the rotating drum. Operator should remain clear of the Roller.</p>
	<p>CAUTION - Install Morse Rollers in accordance with OSHA requirements for enclosure and interlock, etc. For OSHA compliance, see OSHA subpart O.1910.212 "General Requirements for all Machines." Power connections and motor controls must comply with applicable codes.</p> <p>A Morse safety enclosure with safety interlock can be ordered for any Morse drum rotator.</p>	
	<p>WARNING - The 201 Series Drum Rollers are designed to handle one drum of the types listed at the top of page 3 under Machine Description. DO NOT attempt to handle any other type of drum or object. DO NOT exceed the weight capacity.</p>	
	<p>WARNING - Do Not Modify the Unit. Under no circumstances should any modifications be made to the Morse machinery without factory authorization. Any modifications may void the warranty. This machine was designed to perform a specific job and alterations may result in injury to operator or machine.</p>	
	<p>WARNING - No Loose Fitting Clothing. Wear close-fitting clothing and safety equipment appropriate to the job. Loose fitting clothing may become caught on the machinery and cause severe personal injury.</p>	
	<p>CAUTION - Wear safety shoes with non-slip soles and hard toe protection.</p>	
	<p>CAUTION - DO NOT allow drum to impact on floor, ground, etc.</p>	
	<p>WARNING - This product can expose you to chemicals including barium sulfate, cobalt, titanium dioxide, and 2-methylimidazole, which are known to the State of California to cause cancer, and bisphenol-A, which is known to the State of California to cause birth defects or other reproductive harm. For more information go to www.P65Warnings.ca.gov</p>	

Machine Description

The 201 Series Drum Rollers are designed to roll a steel drum, 6" to 28" (15.2 to 71.1 cm) in diameter, and up to 37" (94 cm) long.

- Fixed speed models roll a 22.5" (57.2 cm) diameter drum at 20 RPM.
- The 201VS Series has Variable Speed from 15 to 24 RPM. The drum rotation speed is based on a 22.5" (57.2 cm) diameter 55-gallon (210 liter) steel drum and a 60 Hz, 1725 RPM motor. The drum rotation speed decreases with a 50 Hz motor.

Capacity:

- The maximum liquid load capacity rating is 500 Lb. (227 kg).
- Dry load capacity is 300 Lb. (136 kg).



WARNING - DO NOT exceed these ratings. Exceeding these ratings or handling a drum other than those mentioned above is unsafe and could result in equipment damage, excessive wear, motor overload and shortened service life of transmission components.



Options

Option 1-5P

Roll 1 to 5 gallon size pail

Install this Idler Attachment to roll a 1 to 5 gallon can or pail on a Portable Drum Roller.



A 55-gallon plastic drum can be rotated with the correct POLY option installed.

Option POLY-201

FACTORY installed on new 201 Series Drum Roller. Includes

- 4 Extra wheels to distribute drum weight
- End stop to prevent drum travel
- Chain to assist in tipping drum over onto roller

Kit POLY-201FI

For **CUSTOMER** to install on existing 201 Series Drum Roller.

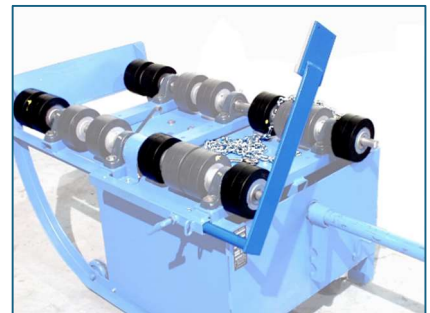

Important

Please read all instructions thoroughly before attempting to operate your new Morse drum handler.

1. **POSITION WHEELS ALONG SHAFTS SO THEY ARE ON EITHER SIDE OF DRUM RIBS.** When rolling, there should be a space between bottom of drum and base plate of Morse roller.
2. When loading, unloading, operating, or maintaining your MORSE drum Roller, always use care and good judgment. Maintain secure footing and a firm hold. Keep hands and loose clothing away from all moving parts. Never allow anyone to be below any part of a raised drum handler or drum. Read operating instructions and review the pictures in the sales brochure before operation.
3. Morse Rollers do not comply with OSHA unless they are installed in accordance with OSHA subpart O, 1910.212 - "General requirements for all machines." Morse Rollers should be installed in accordance with OSHA requirements for enclosure and interlock, etc. Power connections and motor controls must comply with applicable codes.
4. Prior to initial use, inspect all moving parts. Perform necessary inspections, operator training, etc.
5. Review the Material Safety Data Sheet(s) for the material(s) in the drum(s) and take all necessary precautions. Safety shoes, work gloves, hard hat and other personal protective devices are recommended.

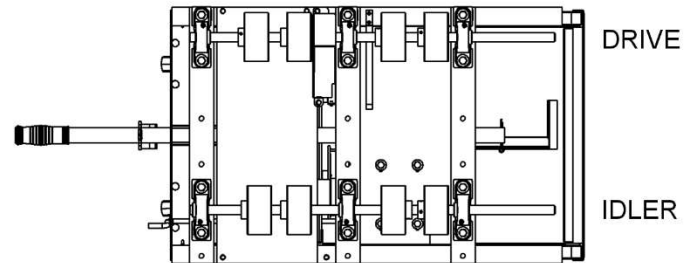

TOP VIEW

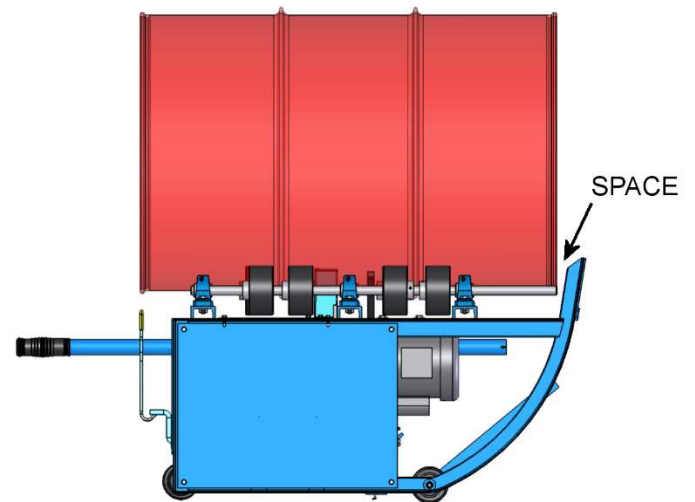

SIDE VIEW

POSITION WHEELS ON EITHER SIDE OF DRUM RIBS

Assembly and Installation Instructions

1. Remove cotter pin from hole in end of tipping lever. Slide lever through hole in back plate of Roller. Replace cotter pin in hole in end of tipping lever and spread cotter pin ends.
2. Next, adjust drive and idler wheels to your particular drum. With provided 1/8" Allen wrench, loosen the two set screws found in each wheel hub. Wheels should be positioned to support the drum at its strongest point; adjacent to ribs (see Figure 1). Put the two inner wheels next to drum ribs to hold drum from moving axially. If the drum rubs the nose piece, readjust the wheels. Tighten wheel set screws.
3. A variety of drum diameters can be accommodated by adjusting the idler wheel assembly toward the drive side for smaller diameters and away from the drive side for larger diameters. Remove the six bearing mount bolts and slide the idler wheel assembly to the proper set of mount holes and refasten the mount bolts. It is very important to ensure that all three pillow bearings are accurately aligned after tightening the mount bolts.
4. Do not put into service without proper motor protection and controls.

The ½ horsepower, single phase 115V 60Hz unit is supplied with a switch, cord and plug. The motor can be plugged into the wall power supply and started with the switch. When starting the unit be careful to stand clear of the Roller as the drum will begin to rotate.

Units ordered with a three phase, explosion proof or 50Hz motor are not supplied with switch, cord, or plug. Customer should provide the proper controls and consult an electrician to complete the wiring.

Rollers equipped with an air motor require 40 psi, 22 scfm. Operating the air motor at higher pressures will reduce the life of the air motor and power transmission components.

Operating Instructions

Video: <https://morsedrum.com/video/201>

1. Position Roller in front of drum to be rotated. Extend tipping lever and tilt Roller forward towards drum until almost vertical. Activate kickstand by using your foot to pull kickstand toward you so the Roller stands by itself.
2. Using a drum hand truck e.g. Morse model 160 or a below-hook drum lifter, carefully place the drum onto the base plate of the drum Roller.



3. With tipping lever fully extended for maximum leverage, engage tipping lever hook on top rim of drum.



4. If necessary, push tipping lever forward to raise kickstand off floor. Release kickstand by pulling yellow kickstand release lock lever toward you.



5. Place foot on axle foot pad for added leverage and pull back on tipping lever until drum is broken over. Reposition foot, and continue lowering until Roller and drum are horizontal.



6. With drum in horizontal position, it is now ready to be moved to desired location to begin drum rolling operation.



7. The speed on the 201VS Series can be adjusted to roll a 22.5" (57 cm) diameter drum from 15 to 24 RPM (13 to 20 RPM on 50Hz models) by turning the variable speed control crank (image 5.3) located in the bottom right corner of the back plate. Turn the crank counterclockwise to increase drum RPM. Turn crank clockwise to decrease RPM.

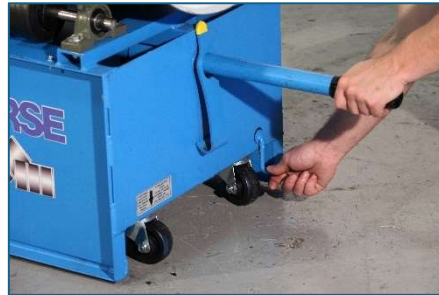

8. For compliance with safety regulations, the drum roller should be moved into an enclosure with safety interlock (image 5.4) before drum rolling is started.

Maintenance:

- Pillow Block Bearings:
 - Grease every 6 to 12 months in ordinary environment.
 - Grease monthly in dirty conditions.
 - Information for bearing lubrication grease types and fill amounts: https://morsedrum.com/ops/2654-P_bearing-grease.pdf
- Drive Chains:
 - Grease every 6-12 months with multiservice lubricant.
 - Example - Whitmore's Surtac® 2000 HD shown at: https://morsedrum.com/ops/MSDS_Surtac_2000.pdf