

CONTENTS

- **Receiving Procedures**
- **Warranty**
- **Safety Information**
- **Machine Description**
- **Operating Instructions**
- **Maintenance**

Receiving Procedures

Every Morse drum handler is inspected prior to shipping. However, damage may be incurred during transit.

- Check for visible damage. If you choose to accept damaged freight, always sign noting the damage on the **BILL OF LADING**.
- Document the damage and have the truck driver sign. We recommend keeping a digital camera at your receiving dock for this purpose.
- Open packages expeditiously to check the condition of the goods. There is only a 24 hour window to notify the carrier of any concealed damage.
- **IMMEDIATELY REPORT ALL DAMAGE TO THE SHIPPING COMPANY!** Then you may contact Morse for assistance with your freight claim.
- Morse Manufacturing will not be held responsible for any damaged freight that is not signed for as damaged.

Delivery to non-business addresses without a loading dock result in additional freight charges. Residential delivery fees, inside delivery fees, re-delivery charges, and lift gate services will be added by the truck line, and are non-negotiable.

Limited 2 Year Warranty

Morse drum handling equipment is guaranteed against defects in workmanship or materials for **TWO YEARS** when used properly within its rated capacity. Warranty does not cover wear from normal use or damage from accident or abuse. Motors and other purchased parts carry the warranties of their manufacturers.

For warranty claims, contact your Morse Dealer to obtain a return authorization number, and for return freight advice. Return freight must be prepaid.

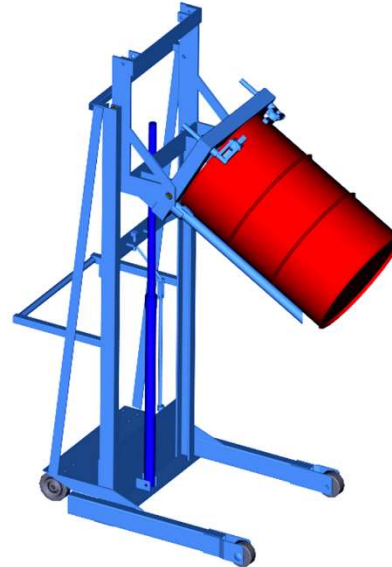

In all instances, liability is limited to the purchase price paid or to repairing or replacing the product. Customer assumes liability for any modifications, unauthorized repairs or parts substitution.

Safety Information

While Morse Manufacturing Co. drum handling equipment is engineered for safety and efficiency, a high degree of responsibility must be placed upon the machine operator to follow safe practices, based primarily on common sense, upon which true safety depends.

Failure to follow the safety precautions in this manual can result in personal injury or property damage. Observe the same precautions as with similar machinery where carelessness in operating or maintenance is hazardous to personnel. Carefully read the safety precautions below and throughout this manual.

Review the Material Safety Data Sheet(s) for the material(s) in the drum(s) and take all necessary precautions. Safety shoes, work gloves, hard hat and other personal protective devices are recommended.

Prior to initial use, inspect all moving parts and test rotation of wheels. Perform necessary inspections, operator training, etc.















DANGER - Indicates a situation which, if not avoided, will result in serious injury or death. This signal word is limited to the most extreme situations.



WARNING - Indicates a situation which, if not avoided, could result in serious injury or death.



CAUTION - Indicates a situation which, if not avoided, can result in damage to the machine.

		CAUTION – Do Not Transport with Drum Raised - ALWAYS LOWER THE DRUM HOLDER TO LOWEST POSITION BEFORE TRANSPORTING. The unit can become unstable when transporting with a raised load.
		WARNING - The MORStak™ Drum Racker is designed to handle one drum of the types listed in the Machine Description. DO NOT attempt to handle any other type of drum or object. DO NOT exceed the weight capacity of 800 Lb (363kg).
		DANGER – Stay Clear of Power Lines. KEEP WELL CLEAR OF POWER LINES. Never approach a power line. Current in a high voltage line may arc some distance from the wire to the steel framed, grounded machine.
		WARNING - Level Floors Only. For operation only on clean, level floors of suitable bearing capacity. Do not use on sloped surfaces, ramps, irregular or debris strewn floors.
		WARNING - Rack Drums in Racks with/ Cradles. Use only with suitable, commercially made racks with drum cradles intended by their manufacturer for use with the type, weight and quantity of drums to be used. Racks and drum cradles must be properly designed, installed and maintained.
		WARNING - Do Not Modify the Unit - Under no circumstances should any modifications be made to the Morse machinery without factory authorization. Any modifications may void the warranty. This machine was designed to perform a specific job and alterations may result in injury to operator or machine.
		WARNING - No Loose Fitting Clothing - Wear close-fitting clothing and safety equipment appropriate to the job. Loose fitting clothing may become caught on the machinery and cause severe personal injury.
		WARNING - Hydraulic Fluid Under Pressure Can Be Hazardous. Escaping hydraulic fluid under pressure can penetrate the skin, causing serious injury. Avoid the hazard by relieving pressure before disconnecting hydraulic lines. Keep hands and body away from pinholes and nozzles, which eject fluid under high pressure. Use a piece of cardboard to search for leaks. If an accident occurs, see a doctor immediately and inform them of the nature of the accident.
		CAUTION - DO NOT allow drum to impact on floor, ground, or dumping station, etc.
		CAUTION - Wear Safety Shoes - Wear safety shoes with non-slip soles and hard toe protection.
		WARNING - This product can expose you to chemicals including barium sulfate, cobalt, titanium dioxide, and 2-methylimidazole, which are known to the State of California to cause cancer, and bisphenol-A, which is known to the State of California to cause birth defects or other reproductive harm. For more information go to www.P65Warnings.ca.gov
		WARNING - This product can expose you to chemicals including lead and arsenic, which are known to the State of California to cause cancer and birth defects or other reproductive harm. For more information go to www.P65Warnings.ca.gov

Machine Description

The MORStak™ Drum Racker is designed to handle one 55 gallon (210 liter) steel or plastic drum with a suitable top lifting rim only (see Figure 3.1). For drums with a removable top, the top must be securely fastened. DO NOT attempt to handle any other type of drum or object. DO NOT exceed the weight capacity of 800 Lb. (363 kg).

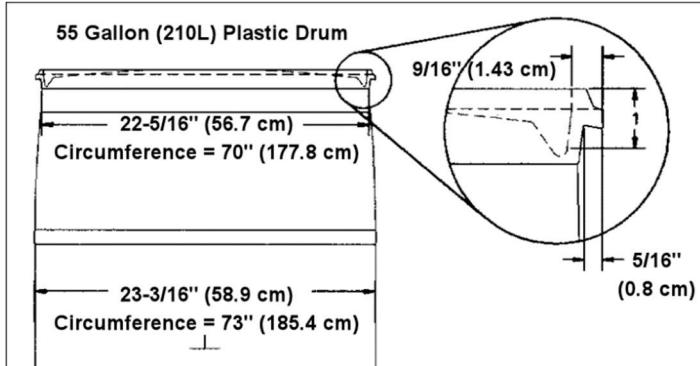

Figure 3.1

- 620 Series Two-Stage MORStak™ will pick or place horizontal drums closely spaced on a storage rack up to 102" high and set them upright on the ground.
- 611 Series Single-Stage MORStak™ can rack up to 56" high.

The front legs require only 5" of clearance between the floor and the lowest beam on the rack

Important

1. Review the Material Safety Data Sheet(s) for the material(s) in the drum(s) and take all necessary precautions. Safety shoes, work gloves, hard hat and other personal protective devices are recommended.
2. Please read all instructions thoroughly before attempting to operate your new Morse drum handler.
3. The MORStak™ Drum Racker has a maximum capacity rating of 800 Lb. (363 kg) full drum and 500 Lb. (227 kg) half-full drum and is designed to lift, move and pour a 55-gallon (210 liter) steel drum. DO NOT exceed these ratings. Exceeding these ratings or handling drums other than those mentioned above is unsafe and could result in equipment damage, excessive wear or awkward handling.
4. MORStak™ Drum Racker is intended for lifting, moving, and holding drums for tilting, pouring or racking. Drums may be lifted upright to or from the floor or other suitable surface on dollies, scales, etc.
5. When loading, unloading, operating, or maintaining your Morse drum handler, always use care and good judgment. Maintain secure footing and a firm hold. Keep hands and loose clothing away from all moving parts. Never allow anyone to be below any part of a raised drum handler or drum. Read operating instructions and review the pictures in the sales brochure before operation.
6. Prior to initial use, inspect all moving parts and test rotation of drum holder assembly. Inspect drum holder assembly for proper operation. Perform necessary load test, inspections, operator training, etc.

Controls

The Morse MORStak™ Drum Racker is manually propelled and steered.

The drum lift and tilt controls are powered by a AC or AIR motor with a momentary switch. There are two functions for the operator to control.

1. LIFT and Lower Function for vertical positioning of drum.

To raise the drum: Turn the motor on by holding the momentary switch in the on position. With the motor on, raise the LIFT handle.

To lower the drum: With the motor off, push in the LOWER handle.

2. TILT Function to control the degree of rotation of drum.

To tilt the drum to horizontal for racking: Turn on the motor by holding momentary switch in the on position. With the motor on, push the tilt handle down.

To return the drum to vertical position: Turn on the motor by holding momentary switch in the on position. Raise the tilt handle up.

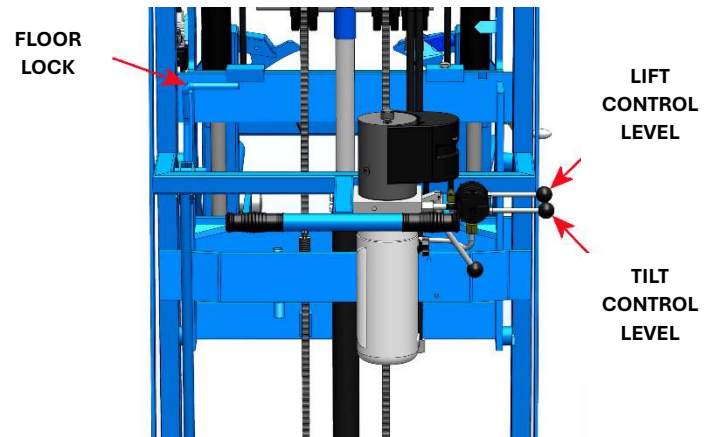

Floor Lock

The floor lock handle is located on the left side of the push handle. Pulling the handle toward the operator until it locks in the down position activates the floor lock. When the floor lock is activated it prevents unwanted free wheeling of the unit. Floor conditions determine the effectiveness of the floor lock. The operator should verify its holding action before depending on it to hold.

Drum Holder Assembly

The drum holder assembly is the component on the MORStak™ that is intended to grab and hold the drum for moving, tilting, and racking. The drum holder assembly moves vertically along the mast and is designed to mechanically grab the drum by its top rim in the vertical position, and support it with two parallel drum-supporting bars in the horizontal position.

A “bridge” between the grip pads at the inside end of the drum holder provides clearance for a typical drum faucet. The operator must see that the drum and faucet are properly oriented to enable the faucet to clear in the space provided by the “bridge” or the faucet may open or be broken and cause a spill



WARNING - Watch Out for Pinch Points. Stay clear of moving parts. Operator should remain behind the push handle during operation of the lift or tilt mechanisms.



WARNING - Tilt Drum ONLY When Arrow is Within Yellow Bar. The indicator is located on the safety screen above the push handle.

When the arrow is within the yellow bar, the bottom of the upright drum will be between 6" and 12" (152-305 mm) above the floor. The operator should make sure the drum holder and drum will not come in contact with the floor, rack or other obstruction during tilting of the drum or the drum could be dislodged, dropped or the MORStak™ could tip over.

Operating Instructions

To Lift an Upright Drum from the Floor and Place Horizontally in a Drum Rack

1. Tilt the drum holder assembly down to the vertical position by pulling up on the "TILT" control lever, located on the left side of the hydraulic power pack. Rotate the grip pad hand wheel counter-clockwise to the full OPEN position.
2. Using the "LIFT" control valve, located on the right side, position the drum holder assembly with the top rim grip pads several inches above the drum.
3. Push the MORStak™ toward the drum, until the two parallel drum-supporting bars are firmly resting against the side of the drum.
4. Lower the drum holder assembly until the bridge meets the top of the drum. In this position, the top rim grip pads should be an inch or two below the top drum rim.
5. Rotate the grip pad hand wheel clockwise to close the grip pads tightly on the drum. Ensure that the chime catches on the two parallel drum-supporting bars are immediately under the top rim of the drum.
6. Raise the "LIFT" control handle. The grip pads and chime catches will lift the drum. Continue to raise only until the drum is 6"-12" (152-305 mm) clear of the floor, or when the arrow indicator is within the yellow bar. This height must be sufficient to permit the drum to swing clear of the floor when tilting to horizontal. Visually inspect the drum holder assembly and position of the drum to verify proper engagement of the grip pads and chime catches



WARNING - Stay Clear of Raised Drum. NEVER allow anyone to be below any part of a raised drum handler or drum. Remain behind the push handle while handling a drum.



WARNING - Do NOT Disengage the Grip Pad when vertical drum is off the ground. When the drum is in the vertical position, lower the drum to the floor before releasing the grip pad.

7. After ensuring that the area in front of the MORStak™ is clear, tilt the drum to the horizontal position by pushing down on the "TILT" control valve. Do not raise the drum until you have reached the racking area. It can be unsafe to move the MORStak™ with a raised drum.

8. After the drum has been tilted to the horizontal position, rotate the grip pad hand wheel counter-clockwise to the full open position. This will allow the drum to be cradled by the two parallel drum-supporting bars and allow it to be racked horizontally. Note: There are interlock switches built into the drum holder which are intended to prevent tilting when the drum is not properly positioned. If the grip pad or the top drum rim is not properly positioned, the tilting function is disabled.
9. Push the unit to the drum storage area and raise or lower the drum to a height that is a couple inches higher than the shelf height. Push the unit into the storage position and carefully lower the drum onto the rack. The two parallel drum-supporting bars should be just below the walls of the drum but still above the rack. This will allow clearance to withdraw the MORStak™ and leave the drum in the storage position.

To Take a Horizontal Drum from a Rack and Place Upright on the Floor

1. Tilt the drum holder assembly to the horizontal position and rotate the grip pad hand wheel counter-clockwise to the full open position. Raise the drum holder assembly to the approximate elevation of the drum to be taken down. Push the MORStak™ up to the drum and adjust the height of the drum grab, if necessary, to clear the drum walls and rack.
2. Roll the MORStak™ forward until the “bridge” meets the head of the drum.

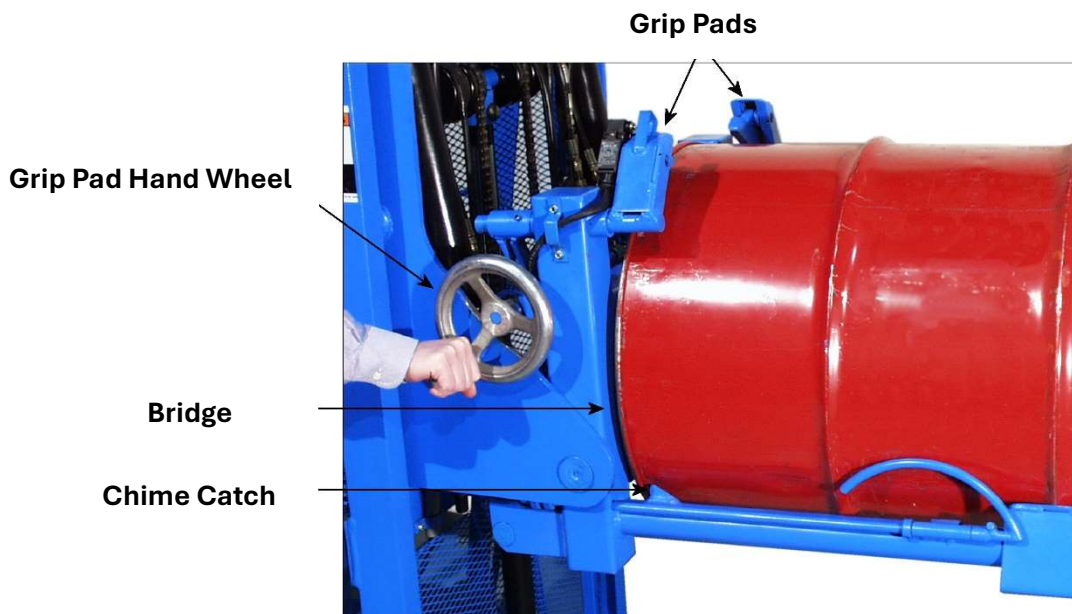

DANGER - It is CRITICAL that the bridge of the drum holder assembly is fully pressed against the top of the drum before lifting from the horizontal position. If the top of the drum is not seated against the bridge, the rim grip pads may not properly engage and the drum can slide off.

Note: There are interlock switches built into the drum holder which are intended to prevent tilting when the drum is not properly positioned. The true safety of this operation, however, depends on the operator correctly positioning the drum in the drum holder, and verifying proper engagement of the rim grip pads.

3. Raise the horizontal drum from the rack a few inches and back the MORStak™ away. Lower the horizontal drum to about 48" (1220 mm) from the floor, or until the yellow arrow indicator is within the yellow bar. Rotate the grip pad hand wheel clockwise to close the grip pads tightly on the drum.



WARNING - Tilt Drum **ONLY** when Arrow is within Yellow Bar.

DO NOT tilt the horizontal drum down if it is less than 48" (1220 mm) to the floor. The drum and/or drum holder can interfere with the floor when tilting and cause the MORStak™ to become unstable and, possibly, fall over.

- Carefully tilt the drum down to the vertical position. Lower the upright drum to the floor and when the weight of the drum is entirely on the floor, rotate the grip pad hand wheel counter-clockwise to the full open position. Raise the drum holder assembly about 12" (305 mm), until the rim grip pads are clearly above the top of the drum. Pull the MORStak™ back to clear the drum.
- Store unit with drum holder assembly in the horizontal position and lowered near the floor

Preventative Maintenance

- Periodic inspection for the general condition of structural and mechanical components is imperative for safe and efficient operation.
- Periodically inspect all moving parts, framework, and contact areas for signs of wear, fatigue, or loosening. Tighten, adjust, or replace parts as necessary to prevent failure and maintain proper function.
- Inspect the hydraulic system for oil drips, hose damage, or other signs of wear. Inspect the level and condition of the hydraulic fluid (see hydraulic pump specification sheet). Replace any parts that show signs of wear.
- Lubricate all moving parts including wheels, casters, and clevis pins.
- Cleanse machine with compressed air.
- Cleanse grease fittings and lubricate.
- Inspect upright assembly for proper adjustment and lubricate rollers.
- Examine hydraulic sump filter cap; clean or replace if necessary.
- Measure hydraulic oil level; fill if necessary.
- Inspect lift and tilt cylinders for leaks.
- Inspect battery; check water level.
- Check battery cables and receptacles.
- Operational check and physical inspection of machine.
- Check wheel condition.