

CONTENTS

- **Receiving Procedures**
- **Warranty**
- **Safety Information**
- **Machine Description**
- **Operating Instructions**
- **Maintenance**

Receiving Procedures

Every Morse drum handler is inspected prior to shipping. However, damage may be incurred during transit.

- Check for visible damage. If you choose to accept damaged freight, always sign noting the damage on the **BILL OF LADING**.
- Document the damage and have the truck driver sign. We recommend keeping a digital camera at your receiving dock for this purpose.
- Open packages expeditiously to check the condition of the goods. There is only a 24 hour window to notify the carrier of any concealed damage.
- **IMMEDIATELY REPORT ALL DAMAGE TO THE SHIPPING COMPANY!** Then you may contact Morse for assistance with your freight claim.
- Morse Manufacturing will not be held responsible for any damaged freight that is not signed for as damaged.

Delivery to non-business addresses without a loading dock result in additional freight charges. Residential delivery fees, inside delivery fees, re-delivery charges, and lift gate services will be added by the truck line, and are non-negotiable.

Limited 2 Year Warranty

Morse drum handling equipment is guaranteed against defects in workmanship or materials for **TWO YEARS** when used properly within its rated capacity. Warranty does not cover wear from normal use or damage from accident or abuse. Motors and other purchased parts carry the warranties of their manufacturers.

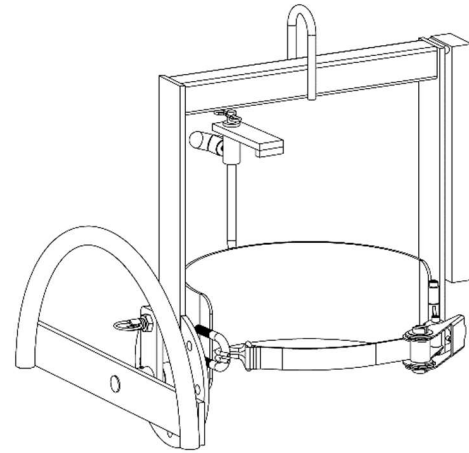

For warranty claims, contact your Morse Dealer to obtain a return authorization number, and for return freight advice. Return freight must be prepaid.

In all instances, liability is limited to the purchase price paid or to repairing or replacing the product. Customer assumes liability for any modifications, unauthorized repairs or parts substitution.

Safety Information

While Morse Manufacturing Co. drum handling equipment is engineered for safety and efficiency, a high degree of responsibility must be placed upon the machine operator to follow safe practices, based primarily on common sense, upon which true safety depends.

Failure to follow the safety precautions in this manual can result in personal injury or property damage. Observe the same precautions as with similar machinery where carelessness in operating or maintenance is hazardous to personnel. Carefully read the safety precautions below and throughout this manual.

Review the Material Safety Data Sheet(s) for the material(s) in the drum(s) and take all necessary precautions. Safety shoes, work gloves, hard hat and other personal protective devices are recommended.

Prior to initial use, inspect all moving parts. Inspect moving parts for proper operation. Perform necessary load test, inspections, operator training, etc.















DANGER - Indicates a situation which, if not avoided, will result in serious injury or death. This signal word is limited to the most extreme situations.



WARNING - Indicates a situation which, if not avoided, could result in serious injury or death.



CAUTION - Indicates a situation which, if not avoided, can result in damage to the machine.

	WARNING - Pail-Karrier™ is designed to handle one pail of the types listed in Machine Description. DO NOT attempt to handle any other type of pail or object.
	WARNING - DO NOT exceed the weight capacity of 200 Lb. (90.7 kg)
	WARNING - Do Not Modify the Unit. Under no circumstances should any modifications be made to the Morse machinery without factory authorization. Any modifications may void the warranty. This machine was designed to perform a specific job and alterations may result in injury to the operator or machine.
	WARNING - DO NOT operate damaged or malfunctioning unit, or a unit with missing parts.
	WARNING - DO NOT lift people or suspend loads over people. Stay clear of suspended loads.
	CAUTION - Wear safety shoes with non-slip soles and hard toe protection.
	CAUTION - DO NOT lift loads higher than necessary.
	WARNING - DO NOT leave suspended loads unattended.
	WARNING - DO NOT remove or obscure warning labels.
	WARNING - DO NOT operate without first having read and understood operating manual.
	CAUTION - DO NOT allow pail to impact on floor, ground, etc.
	WARNING - This product can expose you to chemicals including barium sulfate, cobalt, titanium dioxide, and 2-methylimidazole, which are known to the State of California to cause cancer, and bisphenol-A, which is known to the State of California to cause birth defects or other reproductive harm. For more information go to www.P65Warnings.ca.gov

Machine Description

Model 85-5 Pail-Karrier™ is designed to lift, transport and dispense a standard 5-gallon (19 liter) steel or plastic, pail 11" to 12" (28 to 30.5 cm) in diameter. Maximum capacity is 200 Lb. (91 kg).



Important

1. Review Material Safety Data Sheet(s) for material(s) in pail(s) and take all necessary precautions. Safety shoes, work gloves, hard hat and other personal protective devices are recommended.
2. Please read all instructions thoroughly before attempting to operate your new Morse pail handler.
3. 85-5 Pail-Karrier™ has maximum capacity rating of 200 Lb. for FULL pail and 100 Lb. for HALF-FULL pail, and is designed to lift and move a pail of the size and type noted above. DO NOT exceed this rating. Exceeding this rating or handling pails other than those mentioned above is unsafe and could result in equipment damage, excessive wear, awkward or dangerous handling.
4. When loading, unloading, operating, or maintaining your MORSE pail handler, always use care and good judgment. Maintain secure footing and a firm hold. Keep hands and loose clothing away from all moving parts. Never allow anyone to be below any part of raised pail handler or pail. Read operating instructions and review pictures in sales brochure before operation.
5. 85 Series are "Group 1 structural and mechanical" below-the-hook lifting devices which are covered by the American National Standard ASME B30.20. The user should comply with all aspects of this standard.

Assembly Instructions

1. Place the hand wheel onto the shaft of the drum holder.
2. Insert roll pin into underside of hand wheel collar and gently hammer through hole in shaft of drum holder to secure hand wheel on the shaft.

Operating Instructions

1. Start with Pail-Karrier™ on the floor. Lower hoist and engage hoist hook to lift Pail-Karrier.
2. Lock pail holder in horizontal position for upright pail using spring loaded plunger Tilt-Lock.
3. Raise hoist to lift Pail-Karrier™ clear of floor and transport it to pail.
4. Suspend Pail-Karrier™ at height which aligns pail holder (saddle) with center of pail.
5. If pail has pivoting wire handle, swing it to lay on front side to clear back band of saddle. Push Pail-Karrier™ forward until back band rests firmly against pail.
6. Secure pail:
 - Swing pail's pivoting wire handle to lay on the back band side of pail holder.
 - Drape Web Strap around pail and insert Hook into Eye.
 - Operate ratchet to tighten Web Strap around pail.
 - Adjust top bracket to pail height and secure in place with T-handle.
7. Raise hoist and position pail at pouring station.
8. Before unlocking Tilt-Lock to permit tilting pail, it is recommended that you steady pail and be prepared for its possible tendency to tilt toward its heavier side.
9. With Tilt-Lock unlocked, use Hand Wheel to tilt pail for pouring. Pail pouring angle may be varied, or it can be locked in various positions with Tilt-Lock.
10. After emptying, rotate pail back to vertical position and lower hoist to return empty pail.

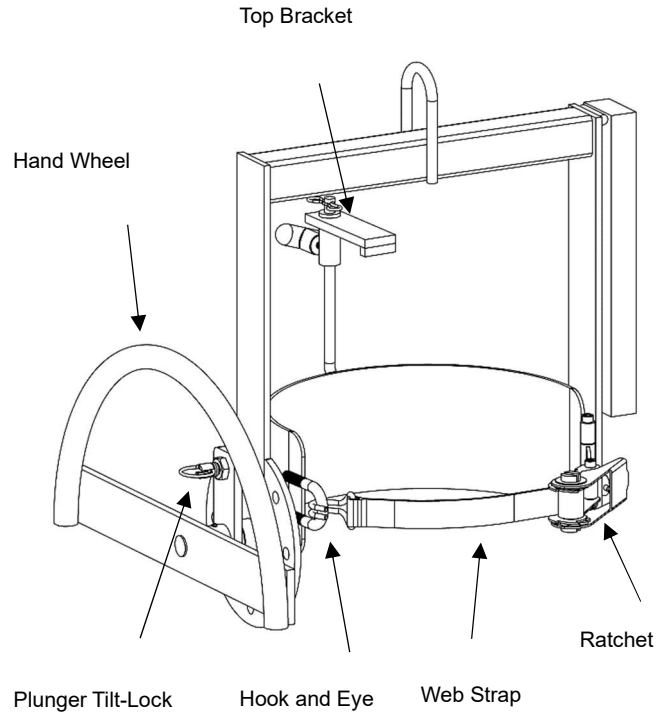

Maintenance

1. Lubricate Tilt-Lock, fulcrum shafts and other moving parts periodically to maintain free action and reduce wear.
2. Periodically inspect all moving parts, framework and contact areas for signs of wear, fatigue or loosening. Tighten, adjust or replace parts as necessary to prevent failure and maintain proper function.