

Contents

	Page
Receiving Procedures.	1
Warranty.	1
Safety Information.	1 - 2
Machine Description.	3
Assembly Instructions.	3
Operating Instructions.	4
Maintenance.	4
Parts Lists and Diagrams.	5
Center of Gravity Information.	6

Operator's Manual
for Morse
Extra Heavy-Duty Forklift-Karrier

Model 285A-GR
 Serial Number 0110 to 1110 (MMYY)

Receiving Procedures

Every Morse drum handler is inspected prior to shipping. However, damage may be incurred during transit.

- Check for visible damage. If you choose to accept damaged freight, always sign noting the damage on the **Bill of Lading**.
- Document the damage and have the truck driver sign. We recommend keeping a digital camera at your receiving dock for this purpose.
- Open packages expeditiously to check the condition of the goods. There is only a 24 hour window to notify the carrier of any concealed damage.
- Immediately **report all damage to the shipping company!** Then you may contact Morse for assistance with your freight claim.
- Morse Manufacturing will not be held responsible for any damaged freight that is not signed for as damaged.

Limited 2 Year Warranty

Morse drum handling equipment is guaranteed against defects in workmanship or materials for two years when used properly within its rated capacity. Warranty does not cover wear from normal use or damage from accident or abuse. Motors and other purchased parts carry the warranties of their manufacturers.

For warranty claims, contact your Morse Dealer to obtain a return authorization number, and for return freight advice. Return freight must be prepaid.

In all instances, liability is limited to the purchase price paid or to repairing or replacing the product. Customer assumes liability for any modifications, unauthorized repairs or parts substitution.

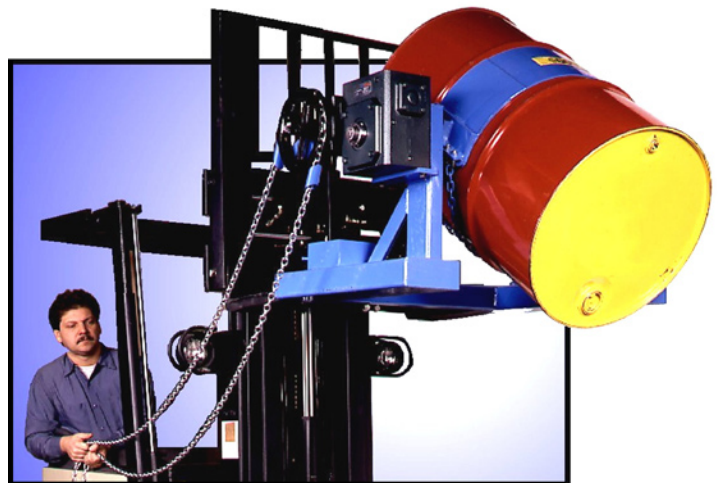

Safety Information

While Morse Manufacturing Co. drum handling equipment is engineered for safety and efficiency, a high degree of responsibility must be placed upon the machine operator to follow safe practices, based primarily on common sense, upon which true safety depends.

Failure to follow the safety precautions in this manual can result in personal injury or property damage. Observe the same precautions as with similar machinery where carelessness in operating or maintenance is hazardous to personnel. Carefully read the safety precautions below and throughout this manual.

Review the Material Safety Data Sheet(s) for the material(s) in the drum(s) and take all necessary precautions. Safety shoes, work gloves, hard hat and other personal protective devices are recommended.

Prior to initial use, inspect all moving parts and test rotation of chain wheel and saddle assembly. Inspect saddle assembly for proper operation. Perform necessary load test, inspections, operator training, etc.

Operator's Manual for Morse Extra Heavy-Duty Forklift-Karrier Model 285A-GR
Serial Number 0110 to 1110 (MMYY)

Safety Information (continued)



DANGER - Indicates a situation which, if not avoided, will result in serious injury or death. This signal word is limited to the most extreme situations.



WARNING - Indicates a situation which, if not avoided, could result in serious injury or death.



CAUTION - Indicates a situation which, if not avoided, can result in damage to the machine.



CAUTION – Do Not Transport with Drum Raised. Always lower the drum holder to lowest position before transporting.



WARNING - The Extra Heavy-Duty Forklift-Karrier is designed to handle one drum of the types listed at the top of page 3. Machine Description. DO NOT attempt to handle any other type of drum or object. DO NOT exceed the weight capacity of 2000 Lb.



WARNING - Do Not Modify the Unit. Under no circumstances should any modifications be made to the Morse machinery without factory authorization. Any modifications may void the warranty. This machine was designed to perform a specific job and alterations may result in injury to operator or machine.



WARNING - No Loose Fitting Clothing. Wear close-fitting clothing and safety equipment appropriate to the job. Loose fitting clothing may become caught on the machinery and cause severe personal injury.



CAUTION - Wear safety shoes with non-slip soles and hard toe protection.



CAUTION: DO NOT allow drum to impact on floor, ground, or dumping station, etc.

**Operator's Manual for Morse Extra Heavy-Duty Forklift-Karrier Model 285A-GR
Serial Number 0110 to 1110 (MMYY)**

Machine Description

The Model 285A-GR Extra Heavy-Duty Forklift-Karrier is designed to lift, transport, and dispense a ribbed 55-gallon steel drum 22.5" in diameter. The maximum full-drum capacity is 2000 Lb. The capacity is derated to 1000 Lb. for a half-full drum. The half-full rating is based on the tilt mechanism's capacity for handling an unbalanced bottom-heavy drum.



Options

A 19" diameter ribbed steel can be handled with model 55/30-19GR Diameter Adaptor. Insert this Diameter Adaptor into the drum holder. Remove the Adaptor to handle your 55-gallon steel drum. Quickly and easily install this Diameter Adaptor in the drum holder. Then simply lift it back out to go back to handling a 55-gallon steel drum.



Important

1. Review the Material Safety Data Sheet(s) for the material(s) in the drum(s) and take all necessary precautions. Safety shoes, work gloves, hard hat and other personal protective devices are recommended.
2. Please read all instructions thoroughly before attempting to operate your new Morse drum handler.
3. The model 285A-GR has a maximum capacity rating of 2000 Lb. full drum and 1000 Lb. half-full drum and is designed to lift, move and pour a 55-gallon steel drum. DO NOT exceed these ratings. Exceeding these ratings or handling drums other than those mentioned above is unsafe and could result in equipment damage, excessive wear or awkward handling.
4. When loading, unloading, operating, or maintaining your MORSE drum handler, always use care and good judgment. Maintain secure footing and a firm hold. Keep hands and loose clothing away from all moving parts. Never allow anyone to be below any part of a raised drum handler or drum. Read operating instructions and review the pictures in the sales brochure before operation.
5. Because the model 285A-GR is a front-end attachment for a forklift, OSHA recommends that "... the truck (forklift) be marked to identify the attachment(s) and show the approximate weight of the truck and attachment combination at maximum elevation with load laterally centered." See center of gravity dimensions of model 285A-GR on page 6 for calculating lost load on your equipment.
6. Prior to initial use, inspect all moving parts and test rotation of chain wheel and saddle assembly. Inspect saddle assembly for proper operation. Perform necessary load test, inspections, operator training, etc.

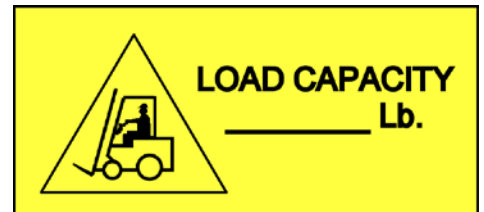

Assembly Instructions

1. Remove the following items from the small cardboard box packaged with the 285A-GR: chain wheel, chain guide w/ pull chain, bushing, 3/16 square key (items: 10, 11, 13, 12, 14).
2. Slide bushing (item 12) and chain guide w/ pull chain (items 11 & 13) onto speed reducer (item 15) input shaft with the chain guide facing outward as pictured in parts diagram.
3. Insert 3/16 square key (item 14) into the key way on the input shaft of the speed reducer. Slide the key up to the bushing.
4. While raising the pull chain up into a loop, slide the chain wheel onto shaft with the keyway in the chain wheel lined up with the square key. Lay the loop of pull chain into the pockets in the chain wheel. Tighten the two set screws on the hub of the chain wheel.
5. Install speed reducer oil vent plug and check oil level as shown in the speed reducer owners manual.
6. Prior to initial use, inspect all moving parts and test rotation of chain wheel and saddle assembly. Inspect load binders and cinch chains for proper operation. Perform necessary load test, inspections, operator training, etc.

CAUTION: DO NOT exceed weight capacity of 2,000 Lb. for FULL drum, 1,000 Lb. for HALF-FULL drum.
CAUTION: DO NOT allow drum to impact on floor, ground, or dumping station, etc.

**Operator's Manual for Morse Extra Heavy-Duty Forklift-Karrier Model 285A-GR
Serial Number 0110 to 1110 (MMYY)**

Operating Instructions

1. Before sliding forklift forks into the fork tubes, adjust forks to an inside spread of 24.5" minimum. Lock forks into position on the forklift carriage.
2. Drive the forklift forward to slip the forks into the fork tubes (see item 20). Tighten tee screws (item 19) to secure the Forklift-Karrier to the forks. Transport Forklift Karrier to drum to be handled.
3. Release the cinch chains and load binders (item 7 and 9) and allow to hang loose.
4. Drive the forklift with the Forklift Karrier near floor level to position the saddle band around the middle of the drum between the ribs.
5. Secure the drum into the saddle by tightening the two cinch chains and load binders around the drum. Secure the snap hook (item 8) the loose ends of the cinch chains, pinning the load binder handles under the chain to prevent inadvertent releasing of the load binder
6. Remove pull chain (item 13) from chain box on base frame (item 20) and place end of loop near operator's seat.
7. Raise forks to clear the floor and transport drum in vertical position to dispensing location.
8. To pour drum: pull on chain (item 13), rotating drum to angle required for dispensing. To control the pouring angle of the drum, pay out one side of chain and pull the other side to prevent the drum from free-wheeling.
9. When dispensing is completed, rotate the drum back to vertical and return drum. While transporting, ensure that the drum is raised away from the floor to prevent the drum bottom from interfering with a pallet or other obstacle.



Maintenance

1. Inspect oil level in speed reducer.
2. Periodically inspect all moving parts, framework, load binders, and contact areas for signs of wear, fatigue, or loosening. Tighten, adjust or replace parts as necessary to prevent failure and maintain proper function.
3. Worn or damaged parts must be properly replaced with the correct, genuine Morse parts.

Operator's Manual for Morse Extra Heavy-Duty Forklift-Karrier Model 285A-GR Serial Number 0110 to 1110 (MMYY)

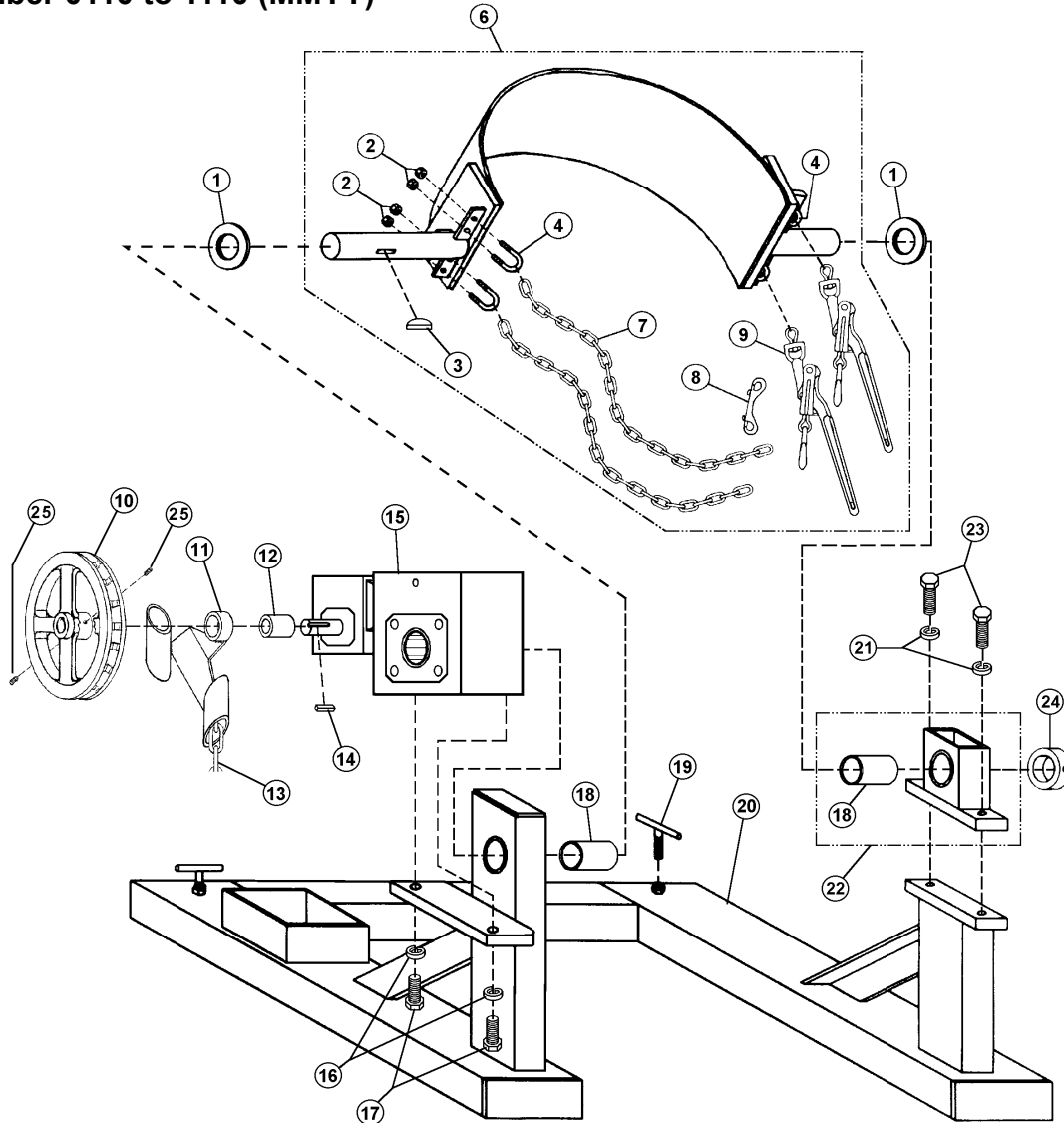

ITEM	QTY.	PART #	DESCRIPTION
1	2	540-P	WASHER, 1-1/2 SAE FL 3" OD
2	8	1169-P	NUT, 3/8-16 REV HEX LOCK
3	1	525-P	KEY, WOODRUFF, SIZE F, ASA1211
4*	4	314-P	U-BOLT, 3/8-16, GR, 300
6	1	557CPT-P	SADDLE ASM, GR W/ CHAINS
7*	2	180-P	CHAIN, CINCH, 3/16 ALLOY 33 LK
8	1	575-P	SNAP HOOK, GR, 30
9*	2	315-P	LOAD BINDER
10*	1	1322-P	POCKET CHAIN WHEEL, 5/8 BORE
11	1	1304-P	GUIDE, POCKET CHAIN WHEEL
12	1	1324-P	BUSHING, 5/8 ID X 1" OD
13*	1	3-285-P	CHAIN, PULL, POCKET 20' LENGTH

ITEM	QTY.	PART #	DESCRIPTION
14	1	1326-P	KEY, SQUARE, 3/16 X 1"
15	1	603-P	SPEED REDUCER, 2 STAGE
16	2	1166-P	WASHER, 3/8 USS 1" OD
17	2	1502-P	HHCS, 7/16-14 X 1-1/4 GR5
18	2	560-P	BEARING, 1-1/2" ID X 2", GR
19	2	58-P	SET SCREW, LOCK TEE, 28
20	1	4902-P	BASE FRAME 285GR W/ BRG
21	2	1474-P	WASHER, 3/8 SPLIT LOCK
22	1	595-P	IDLER BEARING ASM, 285GR
23	2	535-P	HHCS, 3/8-16 X 1-1/4 GR5
24	1	570-P	COLLAR, 1-1/2" ID
25	2	1000-P	SET SCREW, 1/4 - 20 X 1/4

* Recommended spare parts

Operator's Manual for Morse Extra Heavy-Duty Forklift-Karrier Model 285A-GR
Serial Number 0110 to 1110 (MMYY)

CENTER OF GRAVITY DIMENSIONS FOR CALCULATING LOST LOAD ON EQUIPMENT

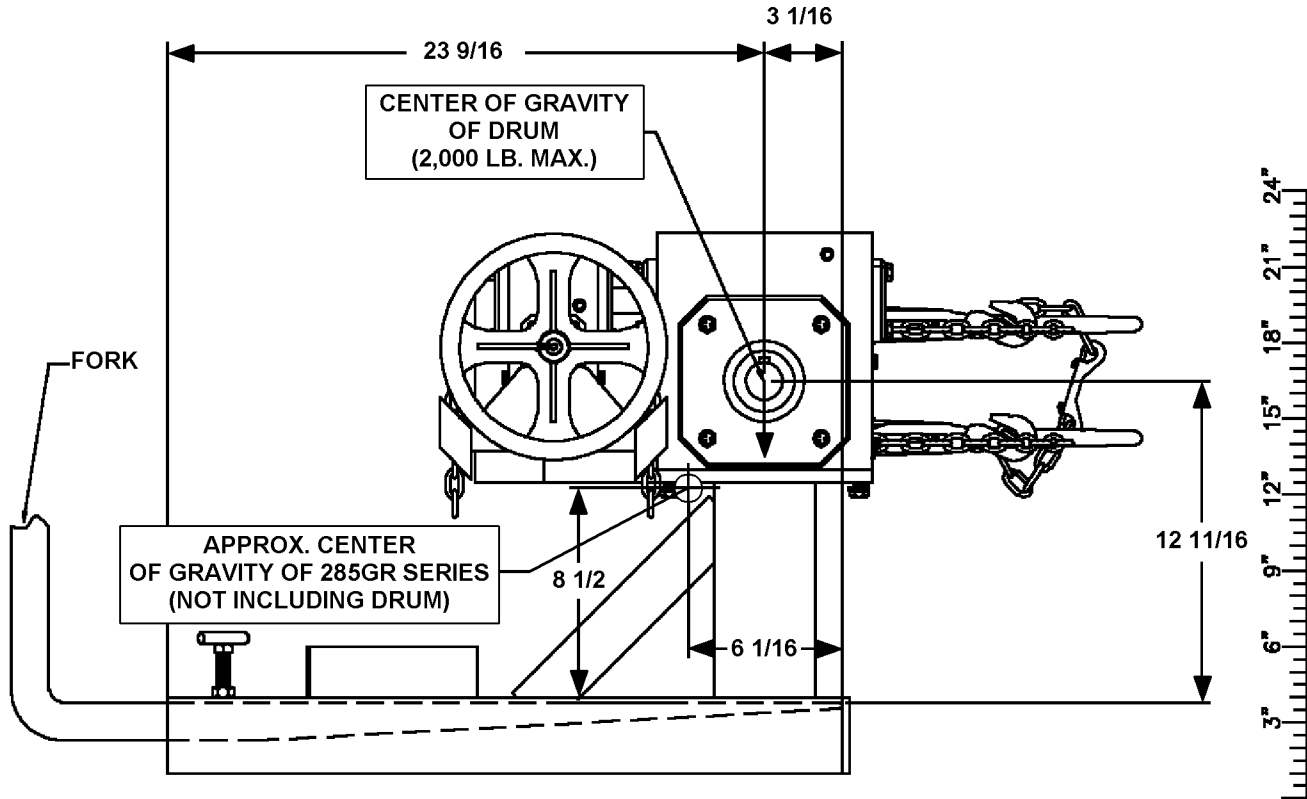

DIMENSIONS ARE MEASURED FROM INSIDE OF FORK TUBE END. THIS WILL GIVE A FIXED POINT TO WHICH LOST LOAD DATA CAN BE DETERMINED. (FORKS MUST BE TOUCHING THIS FORK TUBE END.)

Model	Net Weight
285A-GR	244 Lb.
285G-GR	265 Lb.
285GM-GR	265 Lb.

OPTION	SUBTRACT FROM MODEL
X02	-11 Lb.
X03	-9 Lb.