

CONTENTS

- Receiving Procedures
- Warranty
- Safety Information
- Machine Description
- Assembly Instructions
- Operating Instructions
- Maintenance



Receiving Procedures

Every Morse drum handler is inspected prior to shipping. However, damage may be incurred during transit.

- Check for visible damage. If you choose to accept damaged freight, always sign noting the damage on the **BILL OF LADING**.
- Document the damage and have the truck driver sign. We recommend keeping a digital camera at your receiving dock for this purpose.
- Open packages expeditiously to check the condition of the goods. There is only a 24 hour window to notify the carrier of any concealed damage.
- **IMMEDIATELY REPORT ALL DAMAGE TO THE SHIPPING COMPANY!** Then you may contact Morse for assistance with your freight claim.
- Morse Manufacturing will not be held responsible for any damaged freight that is not signed for as damaged.

Limited 2 Year Warranty

Morse drum handling equipment is guaranteed against defects in workmanship or materials for **TWO YEARS** when used properly within its rated capacity. Warranty does not cover wear from normal use or damage from accident or abuse. Motors and other purchased parts carry the warranties of their manufacturers.

For warranty claims, contact your Morse Dealer to obtain a return authorization number, and for return freight advice. Return freight must be prepaid.

In all instances, liability is limited to the purchase price paid or to repairing or replacing the product. Customer assumes liability for any modifications, unauthorized repairs or parts substitution.

Safety Information

While Morse Manufacturing Co. drum handling equipment is engineered for safety and efficiency, a high degree of responsibility must be placed upon the machine operator to follow safe practices, based primarily on common sense, upon which true safety depends.

Failure to follow the safety precautions in this manual can result in personal injury or property damage. Observe the same precautions as with similar machinery where carelessness in operating or maintenance is hazardous to personnel. Carefully read the safety precautions below and throughout this manual.

Review the Material Safety Data Sheet(s) for the material(s) in the drum(s) and take all necessary precautions. Safety shoes, work gloves, hard hat and other personal protective devices are recommended.

Prior to initial use, inspect all moving parts and test rotation of chain wheel and drum holder assembly. Inspect drum holder assembly for proper operation. Perform necessary load test, inspections, operator training, etc.















DANGER - Indicates a situation which, if not avoided, will result in serious injury or death. This signal word is limited to the most extreme situations.



WARNING - Indicates a situation which, if not avoided, could result in serious injury or death.



CAUTION - Indicates a situation which, if not avoided, can result in damage to the machine.

	WARNING - Kontrol-Karriers are designed to handle one drum of the types listed in Machine Description. DO NOT attempt to handle any other type of drum or object.
	WARNING - DO NOT exceed the weight capacity of 1500Lb (680 kg).
	WARNING - DO NOT operate damaged or malfunctioning unit, or a unit with missing parts.
	WARNING - DO NOT lift people or suspend loads over people. Stay clear of suspended loads.
	WARNING - DO NOT lift loads higher than necessary.
	WARNING - DO NOT leave suspended loads unattended.
	WARNING - DO NOT remove or obscure warning labels.
	WARNING - DO NOT operate without first having read and understood operating manual.
	WARNING - Do Not Modify the Unit. Under no circumstances should any modifications be made to the Morse machinery without factory authorization. Any modifications may void the warranty. This machine was designed to perform a specific job and alterations may result in injury to operator or machine.
	WARNING - No Loose Fitting Clothing. Wear close-fitting clothing and safety equipment appropriate to the job. Loose fitting clothing may become caught on the machinery and cause severe personal injury.
	CAUTION - Wear safety shoes with non-slip soles and hard toe protection.
	CAUTION - DO NOT allow drum to impact on floor, ground, or dumping station, etc.
	WARNING - This product can expose you to chemicals including barium sulfate, cobalt, titanium dioxide, and 2-methylimidazole, which are known to the State of California to cause cancer, and bisphenol-A, which is known to the State of California to cause birth defects or other reproductive harm. For more information go to www.P65Warnings.ca.gov

Machine Description

The Power Tilt Kontrol-Karrier™ is designed to lift, transport, and dispense a ribbed 55-gallon (210 liter) steel drum 22.5" (57.2 cm) in diameter.

Maximum full-drum capacity is 1500 Lb. (680 kg). Capacity is derated to 800 Lb. (363 kg) for a half-full drum. Half-full rating is based on the tilt mechanism's capacity for handling an unbalanced, bottom-heavy drum.

MORSE
 Mfg. Co., Inc.
 E. Syracuse, NY

The Specialist In Drum Handling Equipment

1500 Lb. Max. Capacity
 (680 kg)

Made in U.S.A.

Options

- A smaller diameter drum can be handled with the correct size 55/30M Series Diameter Adapter installed (see Diameter Adapter literature).
- The **Bracket Assembly** (Kit 4556M-P) is **required** to handle a plastic drum without a top rim (see figure 2.1). It is also recommended to more securely handle a fiber drum. You can use the Bracket Assembly with a 55-gallon (210 liter) plastic, steel or fiber drum. The brace at top and bottom of the drum prevents it from slipping lengthways through the drum holder. It adjusts for a drum 31" to 39" tall.
- The **Top Rim Clamp** (Kit 4560BM-P) grips the upper rim of your drum to prevent it from slipping through the drum holder (see figure 2.2). To handle a 55-gallon (210 liter) plastic drum with top rim, you **must** install either the Bracket Assembly or the Top Rim Clamp. You can use the Top Rim Clamp with a 55-gallon (210 liter) plastic, steel or fiber drum with suitable top rim.

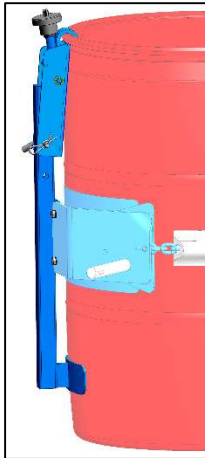
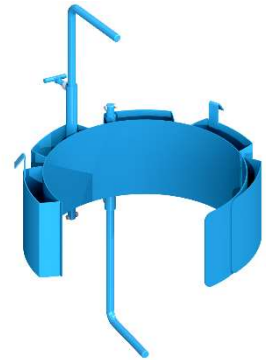

Figure 2.2
 Plastic drum being lifted with Kit # 4560BM-P Top Rim Clamp Assembly installed.

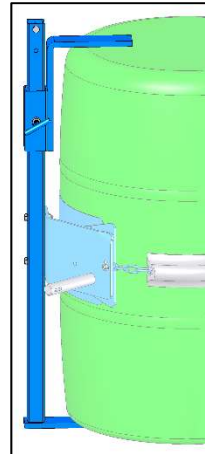

Figure 2.1
 Plastic drum being lifted with Kit # 4556M-P Bracket Assembly installed.

Assembly Instructions

1. Remove the metal screw-plug on top of the speed reducer.
2. Look into the hole to verify oil is in the speed reducer.
3. Install the plastic vent-plug in place of the metal screw-plug to allow internal pressure to equalize with atmospheric pressure.
4. Air motor requires 20 PSI at 22 SCFM. Operating the air motor at higher pressures will reduce the life of the air motor and power transmission components.
5. Prior to initial use, inspect all moving parts and test rotation of saddle assembly. Inspect ratchet web straps for proper operation. Perform necessary load test, inspections, operator training, etc. as prescribed in the ANSI/ASME B30.20 standard.

Operating Instructions

1. With Kontrol-Karrier™ standing on the floor, lower hoist and engage hoist hook into the lifting eye.
2. Raise hoist to lift Kontrol-Karrier™ clear of floor and move it to the drum.
3. Position Kontrol-Karrier™ at a height which aligns the saddle band with the center of the drum. Swing open ratchet hinge plate and strap hinge plates.
4. With the ratchet straps hanging freely, push Kontrol-Karrier™ against the drum to surround the drum with the saddle band.
5. Drape the straps across the front of the drum and thread each strap through slot in ratchet. Operate ratchet to tighten straps against the drum.
6. Raise hoist and position the drum at the pouring station.
7. Pour the drum by pressing the “pour forward” button on the pendant (item 4).
8. After pouring is completed, rotate the drum back to vertical position and lower hoist to return drum to floor.
9. To remove drum: Operate the ratchet to loosen each web strap around the drum. Release straps from ratchets and swing open hinge plates.

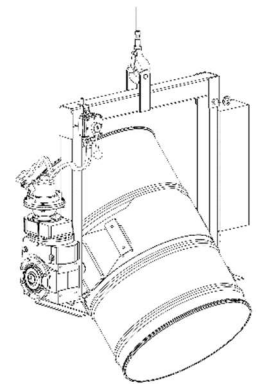
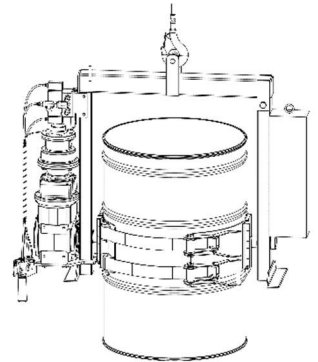

Maintenance

1. Inspect oil level in gear box / speed reducer and fill with high quality, synthetic lubricant for gears if necessary. Use Klubersynth UH1 6-460 (#096060) or equivalent: https://morsedrum.com/ops/SDS_Klubersynth_UH1-SYNTHETIC-OIL_Jan-2015.pdf
2. Periodically inspect all moving parts, framework, ratchet, straps and contact areas for signs of wear, fatigue, or loosening. The web strap should be removed from service & replaced if any of the following are visible:
 - Acid or caustic burns
 - Melting or charring of any part of the strap
 - Holes, tears, cuts, snags or embedded articles
 - Broken or worn stitching in load bearing splices
 - Excessive abrasive wear
3. Perform all inspections, load tests, and maintenance according to the ANSI/ASME B30.20 standard.
4. Ensure all labels are in place. Product labels should be inspected periodically and cleaned as necessary to maintain good legibility. Please contact Morse Mfg. Co. for replacement labels.