

CONTENTS

- **Receiving Procedures**
- **Warranty**
- **Safety Information**
- **Machine Description**
- **Operating Instructions**
- **Maintenance**
- **Assembly Instructions**

Receiving Procedures

Every Morse drum handler is inspected prior to shipping. However, damage may be incurred during transit.

- Check for visible damage. If you choose to accept damaged freight, always sign noting the damage on the **BILL OF LADING**.
- Document the damage and have the truck driver sign. We recommend keeping a digital camera at your receiving dock for this purpose.
- Open packages expeditiously to check the condition of the goods. There is only a 24 hour window to notify the carrier of any concealed damage.
- **IMMEDIATELY REPORT ALL DAMAGE TO THE SHIPPING COMPANY!** Then you may contact Morse for assistance with your freight claim.
- Morse Manufacturing will not be held responsible for any damaged freight that is not signed for as damaged.

Limited 2 Year Warranty

Morse drum handling equipment is guaranteed against defects in workmanship or materials for **TWO YEARS** when used properly within its rated capacity. Warranty does not cover wear from normal use or damage from accident or abuse. Motors and other purchased parts carry the warranties of their manufacturers.

For warranty claims, contact your Morse Dealer to obtain a return authorization number, and for return freight advice. Return freight must be prepaid.

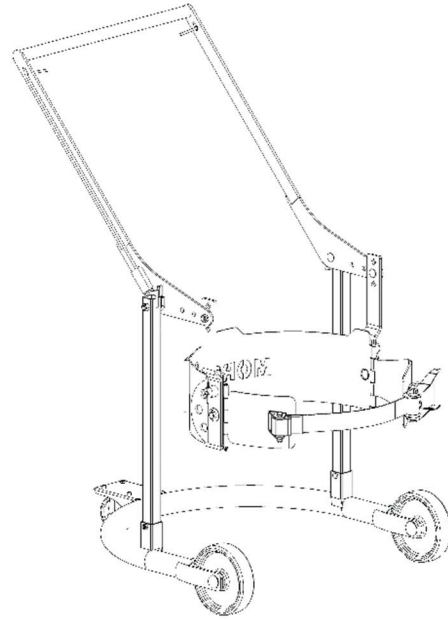

In all instances, liability is limited to the purchase price paid or to repairing or replacing the product. Customer assumes liability for any modifications, unauthorized repairs or parts substitution.

Safety Information

While Morse Manufacturing Co. drum handling equipment is engineered for safety and efficiency, a high degree of responsibility must be placed upon the machine operator to follow safe practices, based primarily on common sense, upon which true safety depends.

Failure to follow the safety precautions in this manual can result in personal injury or property damage. Observe the same precautions as with similar machinery where carelessness in operating or maintenance is hazardous to personnel. Carefully read the safety precautions below and throughout this manual.

Review the Material Safety Data Sheet(s) for the material(s) in the drum(s) and take all necessary precautions. Safety shoes, work gloves, hard hat and other personal protective devices are recommended.

Prior to initial use, inspect all moving parts and test rotation of wheels. Perform necessary inspections, operator training, etc.











DANGER - Indicates a situation which, if not avoided, will result in serious injury or death. This signal word is limited to the most extreme situations.



WARNING - Indicates a situation which, if not avoided, could result in serious injury or death.



CAUTION - Indicates a situation which, if not avoided, can result in damage to the machine.

		<p>CAUTION – Do Not Transport with Drum Raised - ALWAYS LOWER THE DRUM HOLDER TO LOWEST POSITION BEFORE TRANSPORTING.</p>
		<p>WARNING - The Mobile-Karrier™ is designed to handle one drum of the types listed in Machine Description. DO NOT attempt to handle any other type of drum or object. DO NOT exceed the weight capacity of 800 Lb. (363 kg).</p>
		<p>WARNING - Level Floors Only For operation only on clean, level floors of suitable bearing capacity. Do not use on sloped surfaces, ramps, irregular or debris strewn floors.</p>
		<p>WARNING - Do Not Modify the Unit - Under no circumstances should any modifications be made to the Morse machinery without factory authorization. Any modifications may void the warranty. This machine was designed to perform a specific job and alterations may result in injury to operator or machine.</p>
		<p>WARNING - No Loose Fitting Clothing - Wear close-fitting clothing and safety equipment appropriate to the job. Loose fitting clothing may become caught on the machinery and cause severe personal injury.</p>
		<p>CAUTION - DO NOT allow drum to impact on floor, ground, or dumping station, etc.</p>
		<p>CAUTION - Wear Safety Shoes - Wear safety shoes with non-slip soles and hard toe protection.</p>
		<p>WARNING - This product can expose you to chemicals including barium sulfate, cobalt, titanium dioxide, and 2-methylimidazole, which are known to the State of California to cause cancer, and bisphenol-A, which is known to the State of California to cause birth defects or other reproductive harm. For more information go to www.P65Warnings.ca.gov</p>

Machine Description

The Mobile-Karrier™ is designed to lift, transport, and dispense a ribbed 55-gallon (210 liter) steel drum 22.5" (56 cm) in diameter. The maximum capacity is 800 Lb. (363 kg).



Accessories

55/30 Series Diameter Adapters for drum with diameter smaller than 22" (56 cm). To handle a smaller drum, insert the correct size Diameter Adapter into the standard drum holder. See Diameter Adapter info at: <https://morsedrum.com/products/diameter-adapters>

All Diameter Adapters for drum with 17.5" (44.5 cm) diameter or smaller have integrated brackets to prevent drum slipping length-ways.

NOTE: To prevent 30-gallon (114 Liter) PLASTIC drum from slipping install ONE of the following

1. Diameter Adapter 55/30-19B which has integrated brackets
2. Diameter 55/30-19 **AND** either Bracket 4556-P or Top Rim Clamp 4560B-P

IMPORTANT: To prevent a PLASTIC 30 to 55 gallon (114 to 210 Liter) size drum from slipping, you **MUST** install either Top Rim Clamp Kit or Bracket Assembly Kit.

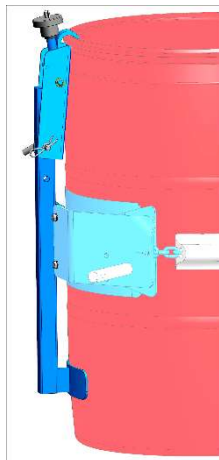
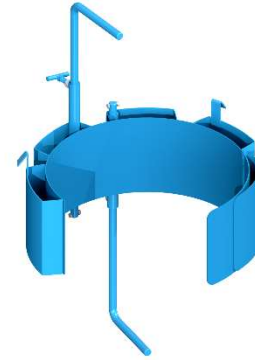

**Top Rim Clamp
 Kit # 4560B-P**

Handle RIMMED plastic drum.

Install the Top Rim Clamp Kit to handle a RIMMED plastic, steel or fiber drum with suitable top rim.

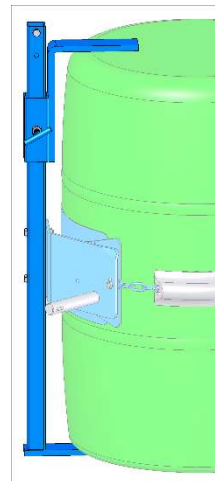

**Bracket Assembly
 Kit # 4556-P**

Required to handle RIMLESS plastic drum. Also recommended for fiber drum.

Bracket adjusts for 31" to 39" (79 to 99 cm) tall drum.

You can also handle a rimmed drum with Bracket installed.

Operating

Instructions

1. Roll the assembled Mobile-Karrier™ to the drum (assembly instructions are on page 5).
2. Grip the push-handle, squeeze both release rods and raise the handle to a position straight up. This lowers the saddle to reach the middle of the drum.
3. Roll the Mobile-Karrier™ forward and push the saddle so that it slips around the drum near the mid-point of the drum.
4. Secure the drum: Drape the web strap across the face of the drum, and thread strap through slot in ratchet.
5. Operate ratchet to tighten strap around drum.
6. Pull down the push-handle to raise the drum. The Mobile-Karrier™ will hold up the drum and may be rolled away carrying the drum.
7. Either one of the two spring loaded plunger tilt locks may be locked to hold the drum upright. Unlocking both will permit the drum to be tilted. Either one may be locked to hold the drum in the tilted position. It is not necessary to lock both tilt locks. Before unlocking the tilt lock it is recommended that you steady the drum and be prepared to resist its tendency to tilt toward its heavy end.
8. Before unloading the drum, release the tilt locks and return the drum to upright.
9. It is necessary to have a firm, two hand hold to lower the push-handle and squeeze the release rods. With both release rods squeezed, the handle will unlock and allow the weight of the drum to make the handle tend to rise. Apply sufficient force to allow the handle to rise slowly to control the descent of the drum.
10. **LEVERAGE AND HEIGHT ADJUSTMENTS:** The Mobile-Karrier™ will hold a vertical drum and raise it as high as 11" (27.9 cm). With the drum held horizontally, there can be as much as 17" (43.2 cm) floor clearance. There are extra holes in the handle plates and links to provide adjustment for various heights and drum weights. The greatest leverage, with the least lift height is obtained when using the handle holes nearest the handle pivot. This position is recommended for ease of use when extra floor clearance is not necessary.

Maintenance

- Periodic inspection for the general condition of structural and mechanical components is imperative for safe and efficient operation.
- Periodically inspect all moving parts, framework, and contact areas for signs of wear, fatigue, or loosening. Tighten, adjust, or replace parts as necessary to prevent failure and maintain proper function.
- Grease wheel bearings periodically. Oil or grease all moving parts including: Tilt locks, fulcrum shafts, links, 1/2" carriage bolts, and the ratchet and pawl.
- Worn or damaged parts must be properly replaced with the correct, genuine Morse parts.
- Tighten all nuts and bolts periodically, except the four 1/2" carriage bolts (assembly steps 1, 2 and 3) which should be just loose enough to permit a hinging motion of the links and handle. The web strap should be removed from service or replaced if any of the following are visible:
 - Acid or caustic burns
 - Melting or charring of any part of the strap
 - Holes, tears, cuts, snags or embedded articles
 - Broken or worn stitching in load bearing splices
 - Excessive abrasive wear

Assembly Instructions

Unpack and identify the following items:

- Handle Assembly
- Left Stanchion
- Right Stanchion
- Saddle Assembly
- Base Assembly
- Hardware Bag

1. Slip stanchions into sockets on base and fasten with 3/8-16 x 2-1/4" bolts and 3/8-16 lock nuts.
2. Attach handle to stanchions as shown using 3" carriage bolts. Run 1/2" lock nuts on far enough to minimize play but allow free pivot of handle.
3. Connect links and 1/2" washers inside handle ends. Note: two 1/2" washers should be "sandwiched" between each link and each handle end. Leave nuts loose to allow links to pivot.

NOTE: The three handle holes (on each side) allow a trade-off between lifting effort (leverage) and range of lift height.

The three holes in each link permit a choice of starting or finishing lift heights.

Hardware Bag Contents

Part	Description	Qty.
807-P	WASHER, 1/2" USS 1-3/8" OD	4
806-P	BOLT, 1/2-13 X 3" CARRIAGE	2
805-P	BOLT, 1/2-13 X 1-1/4" CARRIAGE	2
82-P	HHCS, 3/8-16 X 2-1/4" GR2	2
3981-P	NUT, 3/8-16 NYLON LOCK	2
810-P	NUT, 1/2-13 REV HEX LOCK	4

