

CONTENTS

- **Receiving Procedures**
- **Warranty**
- **Safety Information**
- **Machine Description**
- **Options**
- **Operating Instructions**
- **Maintenance**

Receiving Procedures

Every Morse drum handler is inspected prior to shipping. However, damage may be incurred during transit.

- Check for visible damage. If you choose to accept damaged freight, always sign noting the damage on the **BILL OF LADING**.
- Document the damage and have the truck driver sign. We recommend keeping a digital camera at your receiving dock for this purpose.
- Open packages expeditiously to check the condition of the goods. There is only a 24 hour window to notify the carrier of any concealed damage.
- **IMMEDIATELY REPORT ALL DAMAGE TO THE SHIPPING COMPANY!** Then you may contact Morse for assistance with your freight claim.
- Morse Manufacturing will not be held responsible for any damaged freight that is not signed for as damaged.

Delivery to non-business addresses without a loading dock result in additional freight charges. Residential delivery fees, inside delivery fees, re-delivery charges, and lift gate services will be added by the truck line, and are non-negotiable.

Limited 2 Year Warranty

Morse drum handling equipment is guaranteed against defects in workmanship or materials for **TWO YEARS** when used properly within its rated capacity. Warranty does not cover wear from normal use or damage from accident or abuse. Motors and other purchased parts carry the warranties of their manufacturers.

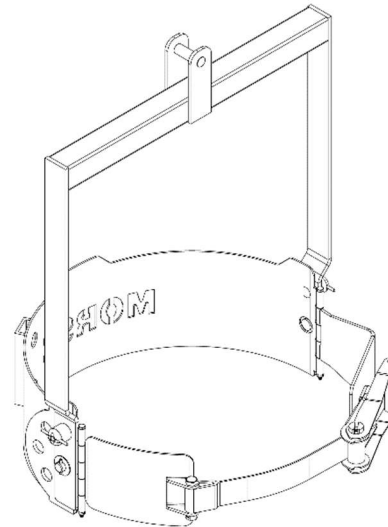

For warranty claims, contact your Morse Dealer to obtain a return authorization number, and for return freight advice. Return freight must be prepaid.

In all instances, liability is limited to the purchase price paid or to repairing or replacing the product. Customer assumes liability for any modifications, unauthorized repairs or parts substitution.

Safety Information

While Morse Manufacturing Co. drum handling equipment is engineered for safety and efficiency, a high degree of responsibility must be placed upon the machine operator to follow safe practices, based primarily on common sense, upon which true safety depends.

Failure to follow the safety precautions in this manual can result in personal injury or property damage. Observe the same precautions as with similar machinery where carelessness in operating or maintenance is hazardous to personnel. Carefully read the safety precautions below and throughout this manual.

Review the Material Safety Data Sheet(s) for the material(s) in the drum(s) and take all necessary precautions. Safety shoes, work gloves, hard hat and other personal protective devices are recommended.

Prior to initial use, inspect all moving parts. Inspect moving parts for proper operation. Perform necessary load test, inspections, operator training, etc.















DANGER - Indicates a situation which, if not avoided, will result in serious injury or death. This signal word is limited to the most extreme situations.



WARNING - Indicates a situation which, if not avoided, could result in serious injury or death.



CAUTION - Indicates a situation which, if not avoided, can result in damage to the machine.

	WARNING – Drum Karrier™ is designed to handle one pail of the types listed in Machine Description. DO NOT attempt to handle any other type of pail or object.
	WARNING - DO NOT exceed the weight capacity of 800 Lb. (363 kg)
	WARNING - Do Not Modify the Unit. Under no circumstances should any modifications be made to the Morse machinery without factory authorization. Any modifications may void the warranty. This machine was designed to perform a specific job and alterations may result in injury to the operator or machine.
	WARNING - DO NOT operate damaged or malfunctioning unit, or a unit with missing parts.
	WARNING - DO NOT lift people or suspend loads over people. Stay clear of suspended loads.
	CAUTION - Wear safety shoes with non-slip soles and hard toe protection.
	CAUTION - DO NOT lift loads higher than necessary.
	WARNING - DO NOT leave suspended loads unattended.
	WARNING - DO NOT remove or obscure warning labels.
	WARNING - DO NOT operate without first having read and understood operating manual.
	CAUTION: DO NOT allow pail to impact on floor, ground, etc.
	WARNING - This product can expose you to chemicals including barium sulfate, cobalt, titanium dioxide, and 2-methylimidazole, which are known to the State of California to cause cancer, and bisphenol-A, which is known to the State of California to cause birth defects or other reproductive harm. For more information go to www.P65Warnings.ca.gov

Machine Description

Model 85i Drum Karrier™ is designed to lift, transport and dispense a standard 55-gallon (210 liter) steel drum 22.5" (57 cm) in diameter. The maximum capacity is 800 Lb. (363 kg). The capacity is derated to 500 Lb. (227 kg) for a half-full drum. The half-full rating is based on the tilt mechanism's capacity for handling an unbalanced bottom-heavy drum.



Options

To Handle a Smaller Drum:

- A smaller diameter drum can be handled with the correct size 55/30 Series Diameter Adaptor (see figure 2.1) installed (see Diameter Adaptor literature).

To Handle a 55-Gallon (210 liter) Plastic or Fiber Drum:

To handle a 55-gallon (210 liter) plastic or fiber drum with top rim, you must install either the Bracket Assembly or the Top Rim Clamp.

The Bracket Assembly (Kit # 4556-P) is required to handle a RIMLESS plastic or fiber drum - a drum without a top rim (see figure 2.2). You can use the Bracket Assembly with a 55-gallon (210 liter) plastic, steel or fiber drum. The brace at top and bottom of the drum prevent it from slipping lengthways through the drum holder. It adjusts for a drum 31" to 39" (79 to 99 cm) tall.

The Top Rim Clamp (Kit # 4560-P) grips the upper rim of your drum to prevent it from slipping through the drum holder (see figure 2.3). You can use the Top Rim Clamp with a 55-gallon (210 liter) plastic, steel or fiber drum with suitable top rim.

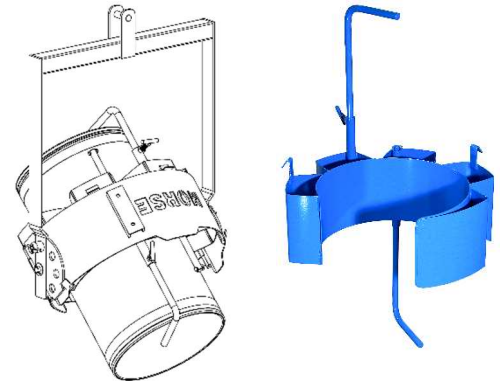

Figure 2.1
55/30 Series
Diameter Adaptors
 Model 85i shown with Diameter Adaptor # 55/30-16 for 15.5" to 16" diameter drum

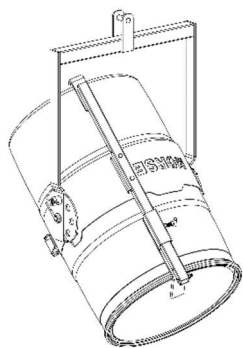

Figure 2.2
Kit # 4556-P Bracket Assembly
 RIMLESS plastic drum shown being lifted with Kit # 4556-P Bracket Assembly installed.

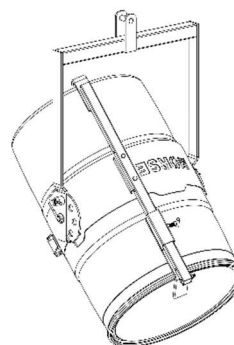

Figure 2.3
4560-P Top Rim Clamp Assembly
 RIMMED plastic drum shown being lifted with Kit # 4560-P Top Rim Clamp Assembly installed.

Important

1. Review the Material Safety Data Sheet(s) for the material(s) in the drum(s) and take all necessary precautions. Safety shoes, work gloves, hard hat and other personal protective devices are recommended.
2. Please read all instructions thoroughly before attempting to operate your new Morse drum handler.
3. The 85 Series Drum Karriers™ have a maximum capacity rating of 800 Lb. (363 kg) for a FULL drum and 500 Lb. (227 kg) for a HALF-FULL drum, and are designed to lift and move a drum of the size and type noted above. DO NOT exceed this rating. Exceeding this rating or handling drums other than those mentioned above is unsafe and could result in equipment damage, excessive wear, awkward or dangerous handling.
4. When loading, unloading, operating, or maintaining your MORSE drum handler, always use care and good judgment. Maintain secure footing and a firm hold. Keep hands and loose clothing away from all moving parts. Never allow anyone to be below any part of a raised drum handler or drum. Read operating instructions and review the pictures in the sales brochure before operation.
5. The 85 Series are a "Group 1 structural and mechanical" below-the-hook lifting device which are covered by the American National Standard ASME B30.20. The user should comply with all aspects of this standard.

Operating Instructions

1. Start with Drum Karrier™ on the floor. Lower hoist and engage hoist hook to lift Drum Karrier™.
2. Raise hoist to lift Drum Karrier™ clear of floor and transport it to the drum.
3. Suspend Drum Karrier™ at a height which aligns drum saddle with center of drum.
4. Swing both hinged bands to the open position. Push Drum Karrier™ against drum so that drum holder (saddle) will encircle drum.
5. Secure the drum: Drape the web strap across the face of the drum.
 - Thread strap through slot in ratchet.
 - Operate ratchet to tighten strap around drum.
6. Either one of the two spring loaded plunger tilt-locks may be locked to hold the drum upright. It is not necessary to lock both of them.
7. Raise hoist and position drum at pouring station.

Operating Instructions Continued

8. Before unlocking the tilt-lock(s) to permit tilting the drum, it is recommended that you steady the drum and be prepared for its possible tendency to tilt toward its heavier side.
9. With tilt-locks unlocked, manually tilt the drum for pouring over the drum band. The drum pouring angle may be varied or it can be locked in various positions by one of the tilt-locks.
10. After emptying, rotate drum back to vertical position and lower hoist to return the empty drum.
11. To remove drum: Squeeze the ratchet release lever and open all the way to unlock. Then release the tension on the strap. Allow enough slack in the strap in order to remove strap from ratchet. Swing both hinged bands to the open position.

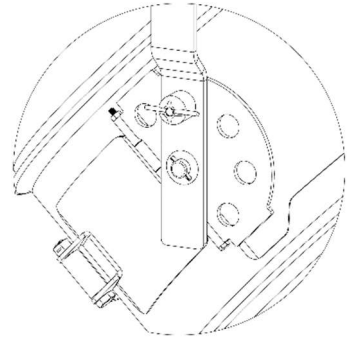

Tilt Lock

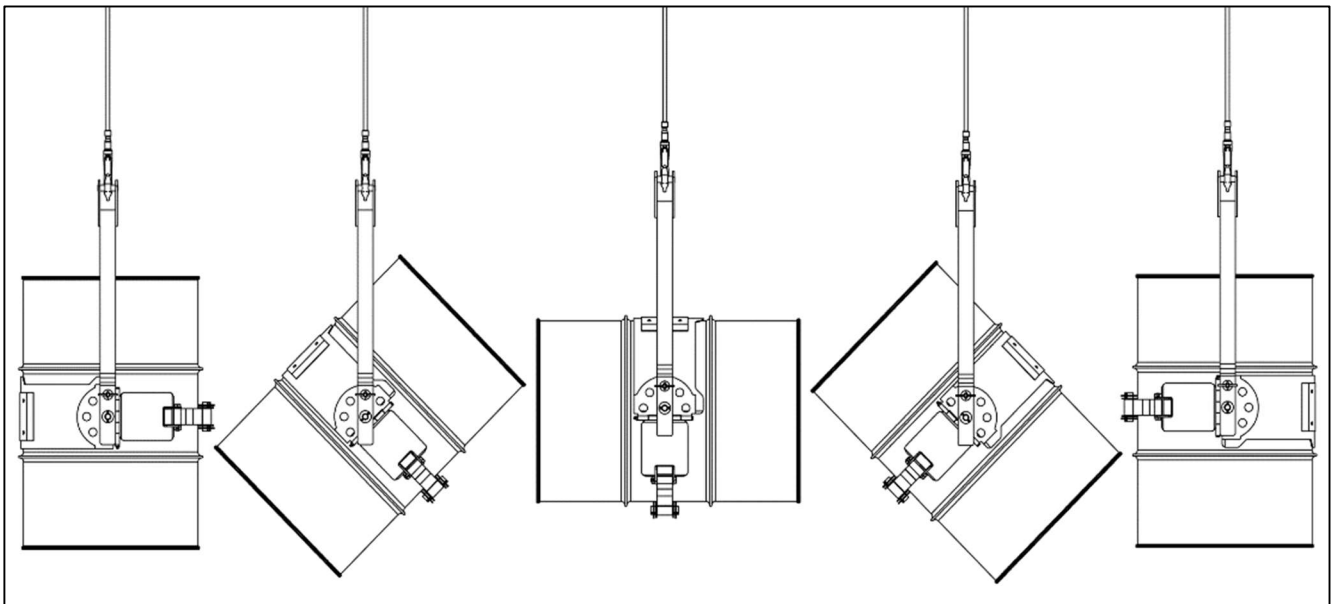

Model 85i Tilt Lock Positions

Maintenance

Lubricate ratchet, tilt locks, fulcrum shafts and other moving parts periodically to maintain free action and reduce wear.

Periodically inspect all moving parts, framework and contact areas for signs of wear, fatigue or loosening. Tighten, adjust or replace parts as necessary to prevent failure and maintain proper function. The web strap should be removed from service or replaced if any of the following are visible:

- Acid or caustic burns
- Melting or charring of any part of the strap
- Holes, tears, cuts, snags or embedded articles
- Broken or worn stitching in load bearing splices
- Excessive abrasive wear