

CONTENTS

- **Receiving Procedures**
- **Warranty**
- **Safety Information**
- **Description**
- **Installation**
- **Operating Instructions**

Receiving Procedures

Every Morse drum handler is inspected prior to shipping. However, damage may be incurred during transit.

- Check for visible damage. If you choose to accept damaged freight, always sign noting the damage on the **BILL OF LADING**.
- Document the damage and have the truck driver sign. We recommend keeping a digital camera at your receiving dock for this purpose.
- Open packages expeditiously to check the condition of the goods. There is only a 24 hour window to notify the carrier of any concealed damage.
- **IMMEDIATELY REPORT ALL DAMAGE TO THE SHIPPING COMPANY!** Then you may contact Morse for assistance with your freight claim.
- Morse Manufacturing will not be held responsible for any damaged freight that is not signed for as damaged.

Delivery to non-business addresses without a loading dock result in additional freight charges. Residential delivery fees, inside delivery fees, re-delivery charges, and lift gate services will be added by the truck line, and are non-negotiable.

Limited 2 Year Warranty

Morse drum handling equipment is guaranteed against defects in workmanship or materials for **TWO YEARS** when used properly within its rated capacity. Warranty does not cover wear from normal use or damage from accident or abuse. Motors and other purchased parts carry the warranties of their manufacturers.



For warranty claims, contact your Morse Dealer to obtain a return authorization number, and for return freight advice. Return freight must be prepaid.

In all instances, liability is limited to the purchase price paid or to repairing or replacing the product. Customer assumes liability for any modifications, unauthorized repairs or parts substitution.

Safety Information

While Morse Manufacturing Co. drum handling equipment is engineered for safety and efficiency, a high degree of responsibility must be placed upon the machine operator to follow safe practices, based primarily on common sense, upon which true safety depends.

Failure to follow the safety precautions in this manual can result in personal injury or property damage. Observe the same precautions as with similar machinery where carelessness in operating or maintenance is hazardous to personnel. Carefully read the safety precautions below and throughout this manual.

Review the Material Safety Data Sheet(s) for the material(s) in the drum(s) and take all necessary precautions. Safety shoes, work gloves, hard hat and other personal protective devices are recommended.

Prior to initial use, inspect all moving parts and test rotation of wheels. Perform necessary inspections, operator training, etc.













DANGER - Indicates a situation which, if not avoided, will result in serious injury or death. This signal word is limited to the most extreme situations.



WARNING - Indicates a situation which, if not avoided, could result in serious injury or death.



CAUTION - Indicates a situation which, if not avoided, can result in damage to the machine.

	DANGER – Live electrical parts could cause death or shock.
	DANGER - Lock out and tag out power before working on any electrical wiring.
	DANGER - Only qualified electricians are to do electrical work.
	DANGER - Do not remove or install any parts while housing is connected to power.
	WARNING - Changes made to the machine could cause death, injury or damage.
	WARNING - Do Not Modify the Unit - Under no circumstances should any modifications be made to the Morse machinery without factory authorization. Any modifications may void the warranty. This machine was designed to perform a specific job and alterations may result in injury to operator or machine.
	WARNING - Rotating parts could cause death or severe injury.
	WARNING - No Loose Fitting Clothing. Wear close-fitting clothing and safety equipment appropriate to the job. Loose fitting clothing may become caught on the machinery and cause severe personal injury.
	CAUTION - Wear Safety Shoes - Wear safety shoes with non-slip soles and hard toe protection.
	WARNING - This product can expose you to chemicals including barium sulfate, cobalt, titanium dioxide, and 2-methylimidazole, which are known to the State of California to cause cancer, and bisphenol-A, which is known to the State of California to cause birth defects or other reproductive harm. For more information go to www.P65Warnings.ca.gov

Description

The Morse 456 Series Control Package includes the following features: a start & stop button along with a red emergency stop button. A lockable main disconnect to shut off and lock out power to the unit. A 24v dc control supply. Wire terminals for external connection of a safety interlock switch. A timer for controlling the amount of tumbling time, from a few seconds to 16 hours.

Installation

Secure control mast to the floor using four 3/8" diameter x 3-1/2" long stud anchors (not included). Install mast outside safety enclosure. Install interlock switch to safety enclosure. See enclosure installation instructions.

Route wiring to interlock switch and motor. All wiring must be to national and local code. Use an explosion proof conduit to bring wires into control box.

Connect control panel to motor. See control panel wiring diagram and connection drawing on motor nameplate. Terminals T1, T2 and T3 are marked on terminal block inside control panel housing. Adjust overload to match motor amp draw at desired voltage.

With power to circuit locked out and tagged out, connect control panel to plant circuit.

Close panel before powering up.

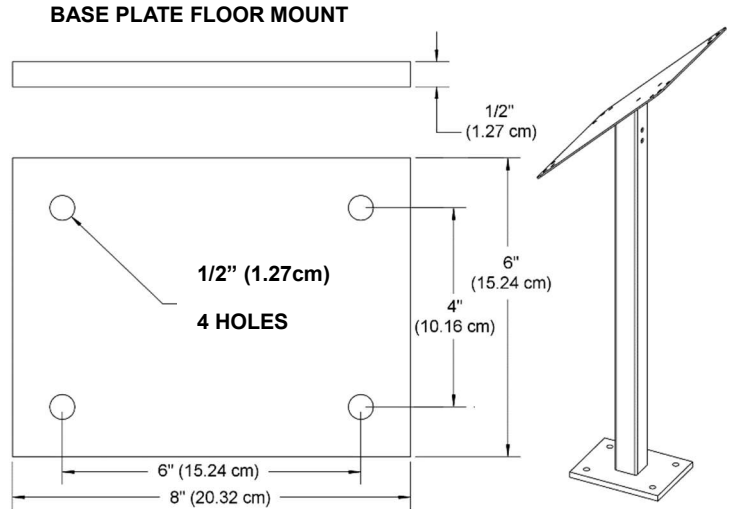

Operating Instructions

Load drum onto drum rotator

Power up control panel. Press green START button.

Set timer to rotate drum for desired time, from just a few seconds to 16 hours. Use buttons to adjust seconds, minutes & hours.

Load drum onto load plate. Follow procedure in 456 Series Operator's Manual.

Rotate drum. Follow procedure in 456 Series Operator's Manual.

After rotation, return drum to upright for unloading. Follow procedure in 456 Series Operator's Manual.

Press black STOP button to power down control panel. A red EMERGENCY STOP button is included in case of emergency. Push to activate and twist to release.

