

CONTENTS

- Receiving Procedures
- Warranty
- Safety Information
- Machine Description
- Accessories
- Operating Instructions
- Maintenance

Receiving Procedures

Every Morse drum handler is inspected prior to shipping. However, damage may be incurred during transit.

- Check for visible damage. If you choose to accept damaged freight, always sign noting the damage on the **BILL OF LADING**.
- Document the damage and have the truck driver sign. We recommend keeping a digital camera at your receiving dock for this purpose.
- Open packages expeditiously to check the condition of the goods. There is only a 24 hour window to notify the carrier of any concealed damage.
- **IMMEDIATELY REPORT ALL DAMAGE TO THE SHIPPING COMPANY!** Then you may contact Morse for assistance with your freight claim.
- Morse Manufacturing will not be held responsible for any damaged freight that is not signed for as damaged.

Delivery to non-business addresses without a loading dock result in additional freight charges. Residential delivery fees, inside delivery fees, re-delivery charges, and lift gate services will be added by the truck line, and are non-negotiable.

Limited 2 Year Warranty

Morse drum handling equipment is guaranteed against defects in workmanship or materials for **TWO YEARS** when used properly within its rated capacity. Warranty does not cover wear from normal use or damage from accident or abuse. Motors and other purchased parts carry the warranties of their manufacturers.

For warranty claims, contact your Morse Dealer to obtain a return authorization number, and for return freight advice. Return freight must be prepaid.



In all instances, liability is limited to the purchase price paid or to repairing or replacing the product. Customer assumes liability for any modifications, unauthorized repairs or parts substitution.

Safety Information

While Morse Manufacturing Co. drum handling equipment is engineered for safety and efficiency, a high degree of responsibility must be placed upon the machine operator to follow safe practices, based primarily on common sense, upon which true safety depends.

Failure to follow the safety precautions in this manual can result in personal injury or property damage. Observe the same precautions as with similar machinery where carelessness in operating or maintenance is hazardous to personnel. Carefully read the safety precautions below and throughout this manual.

Review the Material Safety Data Sheet(s) for the material(s) in the drum(s) and take all necessary precautions. Safety shoes, work gloves, hard hat and other personal protective devices are recommended.

Prior to initial use, inspect all moving parts and test rotation of chain wheel and drum holder assembly. Inspect drum holder assembly for proper operation. Perform necessary load test, inspections, operator training, etc.















DANGER - Indicates a situation which, if not avoided, will result in serious injury or death. This signal word is limited to the most extreme situations.



WARNING - Indicates a situation which, if not avoided, could result in serious injury or death.



CAUTION - Indicates a situation which, if not avoided, can result in damage to the machine.

	WARNING - Kontrol-Karriers are designed to handle one drum of the types listed in Machine Description. DO NOT attempt to handle any other type of drum or object.
	WARNING - DO NOT exceed the weight capacity of 1500 Lb. (680 kg).
	WARNING - DO NOT operate damaged or malfunctioning unit, or a unit with missing parts.
	WARNING - DO NOT lift people or suspend loads over people. Stay clear of suspended loads.
	WARNING - DO NOT lift loads higher than necessary.
	WARNING - DO NOT leave suspended loads unattended.
	WARNING - DO NOT remove or obscure warning labels.
	WARNING - DO NOT operate without first having read and understood operating manual.
	WARNING - Do Not Modify the Unit. Under no circumstances should any modifications be made to the Morse machinery without factory authorization. Any modifications may void the warranty. This machine was designed to perform a specific job and alterations may result in injury to operator or machine.
	WARNING - No Loose Fitting Clothing. Wear close-fitting clothing and safety equipment appropriate to the job. Loose fitting clothing may become caught on the machinery and cause severe personal injury.
	CAUTION - Wear safety shoes with non-slip soles and hard toe protection.
	CAUTION - DO NOT allow drum to impact on floor, ground, or dumping station, etc.
	WARNING - This product can expose you to chemicals including barium sulfate, cobalt, titanium dioxide, and 2-methylimidazole, which are known to the State of California to cause cancer, and bisphenol-A, which is known to the State of California to cause birth defects or other reproductive harm. For more information go to www.P65Warnings.ca.gov

Machine Description

Model 185A-HD Heavy-Duty Kontrol-Karrier is designed to lift, transport, and dispense a ribbed 55-gallon (210 liter) steel or fiber drum 22" to 23.5" (56 to 59.7 cm) in diameter.

Maximum full-drum capacity is 1500 Lb. (680 kg). Capacity is derated to 800 Lb. (434 kg) for a half-full drum. Half-full rating is based on the tilt mechanism's capacity for handling an unbalanced bottom-heavy drum.



Accessories

55/30 Series Diameter Adapters for drum with diameter smaller than 22" (56 cm). To handle a smaller drum, insert the correct size Diameter Adapter into the standard drum holder. See Diameter Adapter info at: <https://morsedrum.com/products/diameter-adapters>

All Diameter Adapters for drum with 17.5" (44.5 cm) diameter or smaller have integrated brackets to prevent drum slipping length-ways.

NOTE: To prevent 30-gallon (114 Liter) PLASTIC drum from slipping install ONE of the following

1. Diameter Adapter 55/30-19B which has integrated brackets
2. Diameter 55/30-19 **AND** Bracket 4556-P or Top Rim Clamp 4560B-P

IMPORTANT: To prevent a PLASTIC 30 to 55 gallon (114 to 210 Liter) size drum from slipping, you **MUST** install either Top Rim Clamp Kit or Bracket Assembly Kit.

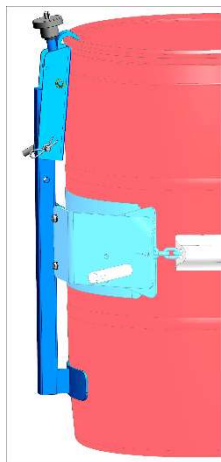
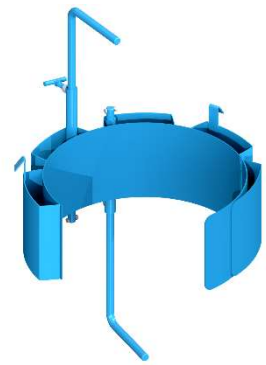

Top Rim Clamp Kit # 4560B-P

Handle RIMMED plastic drum.

Install the Top Rim Clamp Kit to handle a RIMMED plastic, steel or fiber drum with suitable top rim.

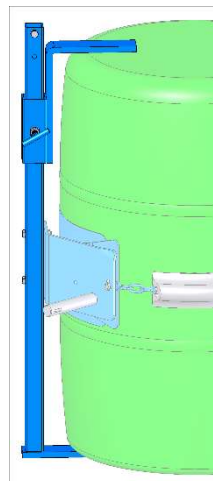

Bracket Assembly Kit # 4556-P

Required to handle RIMLESS plastic drum. Also recommended for fiber drum.

Bracket adjusts for 31" to 39" (79 to 99 cm) tall drum.

You can also handle a rimmed drum with Bracket installed.



**Kit # 3900-P
MORStop™ Tilt-Brake**

Automatically holds drum tilt angle until you move it.

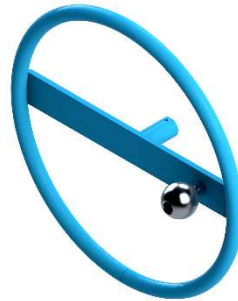

**Kit # 2690-P
Hand Wheel**

16" (40.6 cm) diameter Hand Wheel with speed knob.

Replaces standard pull chain to turn drum.



**Kit # 1460-P
Hand Crank**

9" (22.9 cm) Diameter Hand Crank.

Replaces standard pull chain to turn drum.



**Kit # 6315-P
Fork Pockets**

Add fork pockets to below-hook drum handler

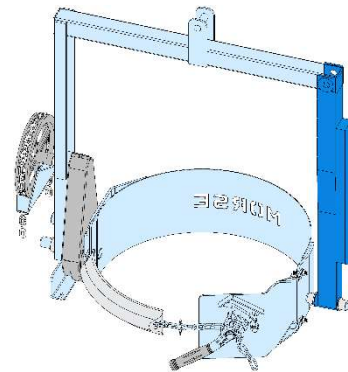

**Kit # 4623-P
Counterweight**

Levels unit without drum

Important

1. Please read all instructions thoroughly before attempting to operate your new Morse drum handler.
2. When loading, unloading, operating, or maintaining your Morse drum handler, always use care and good judgment. Maintain secure footing and a firm hold. Keep hands and loose clothing away from all moving parts. Never allow anyone to be below any part of a raised drum handler or drum. Read operating instructions and review the pictures in the sales brochure before operation.
3. The 185 Heavy-Duty Series are a "Group 1 structural and mechanical" below-the-hook lifting device which are covered by the American National Standard ASME B30.20. The user should comply with all aspects of this standard.

Operating Instructions

1. Start with Kontrol-Karrier on floor. Lower hoist and engage hoist hook to off-center lift point. Empty Kontrol-Karrier will hang plumb from off-center lift point.
2. Raise hoist to lift Kontrol-Karrier clear of floor and transport it to the drum.
3. Suspend Kontrol-Karrier at height which aligns drum holder (saddle) with center of drum.
4. With binder chain hanging freely, swing ratchet hinge plate to open position. Push Kontrol-Karrier against drum so that saddle will encircle drum.
5. Secure drum: drape binder chain across the face of the drum and engage a link into notch in ratchet (shown below right). Turn ratchet handle clockwise to tighten chain. If chain doesn't cinch tightly on drum, lift pawl to loosen and release chain and try again with different link in notch. Firm hand pressure on ratchet handle should tighten chain sufficiently to hold drum. **DO NOT** use mechanical aids such as a pipe to extend handle for extra leverage.
6. Move hoist hook to lift point centered over drum.
7. Raise hoist and position drum at pouring station.
8. Pour drum by pulling on pull chain and rotating drum to suitable pouring angle. For best control of drum pouring angle, pay out one side of chain loop while pulling in the other side, thus being able to hold back drum rotation. Chain lock on bottom of power arm can be used to prevent drum rotation. To do so, crisscross chain and insert in each notch of chain lock. If drum handler is equipped with MORStop™ Tilt-Brake, there is no need to hold tension on both sides of chain loop. Braking is immediate and self actuating, without additional steps by the operator.

To add MORStop™ Tilt-Brake to an existing drum handler, order Kit # 3900-P.

9. After pouring is completed, rotate drum back to vertical position and lower hoist to return drum to floor.
10. To remove drum: Pull ratchet handle clockwise to relieve pressure on ratchet teeth. Lift pawl handle to release teeth engagement and rotate ratchet to loosen chain and allow its removal from notch.

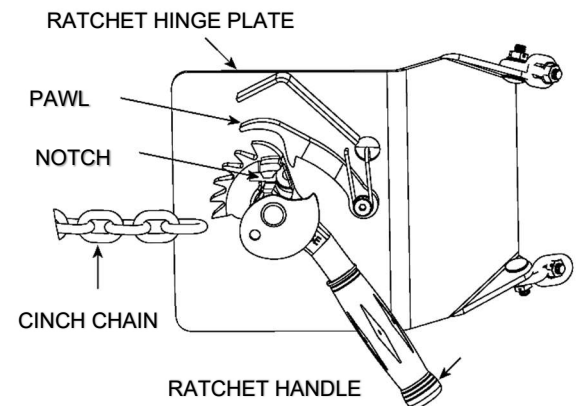

Maintenance

1. Periodic inspection for general condition of structural and mechanical components is imperative for safe and efficient operation.
2. Lubricate gear teeth and roller chain.
3. Clean and oil ratchet, pawl and other moving parts periodically. Clean and lubricate more often in environments where dust, dirt or other foreign particles will effect performance of moving parts.
4. Periodically inspect all moving parts, framework, drum holder and contact areas for signs of wear, fatigue, or loosening. Tighten, adjust, or replace parts as necessary to prevent failure and maintain proper function.
5. Worn or damaged parts must be properly replaced with the correct, genuine Morse parts.