

## CONTENTS

- **Receiving Procedures**
- **Warranty**
- **Safety Information**
- **Machine Description**
- **Installation Instructions**
- **Operating Instructions**
- **Maintenance**

### Receiving Procedures

Every Morse drum handler is inspected prior to shipping. However, damage may be incurred during transit.

- Check for visible damage. If you choose to accept damaged freight, always sign noting the damage on the **BILL OF LADING**.
- Document the damage and have the truck driver sign. We recommend keeping a digital camera at your receiving dock for this purpose.
- Open packages expeditiously to check the condition of the goods. There is only a 24 hour window to notify the carrier of any concealed damage.
- **IMMEDIATELY REPORT ALL DAMAGE TO THE SHIPPING COMPANY!** Then you may contact Morse for assistance with your freight claim.
- Morse Manufacturing will not be held responsible for any damaged freight that is not signed for as damaged.

Delivery to non-business addresses without a loading dock result in additional freight charges. Residential delivery fees, inside delivery fees, re-delivery charges, and lift gate services will be added by the truck line, and are non-negotiable.

### Limited 2 Year Warranty

Morse drum handling equipment is guaranteed against defects in workmanship or materials for **TWO YEARS** when used properly within its rated capacity. Warranty does not cover wear from normal use or

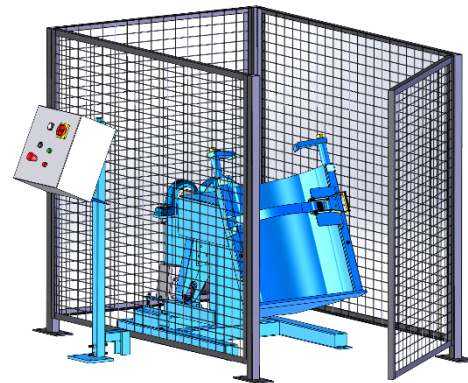

damage from accident or abuse. Motors and other purchased parts carry the warranties of their manufacturers.

For warranty claims, contact your Morse Dealer to obtain a return authorization number, and for return freight advice. Return freight must be prepaid.

In all instances, liability is limited to the purchase price paid or to repairing or replacing the product. Customer assumes liability for any modifications, unauthorized repairs or parts substitution.

### Safety Information

While Morse Manufacturing Co. drum handling equipment is engineered for safety and efficiency, a high degree of responsibility must be placed upon the machine operator to follow safe practices, based primarily on common sense, upon which true safety depends.

Failure to follow the safety precautions in this manual can result in personal injury or property damage. Observe the same precautions as with similar machinery where carelessness in operating or maintenance is hazardous to personnel. Carefully read the safety precautions below and throughout this manual.

Review the Material Safety Data Sheet(s) for the material(s) in the drum(s) and take all necessary precautions. Safety shoes, work gloves, hard hat and other personal protective devices are recommended.

Prior to initial use, inspect all moving parts and test rotation of drum holder with a weighted drum. Inspect drum holder for proper operation. Perform necessary inspections, operator training, etc.













**DANGER** - Indicates a situation which, if not avoided, will result in serious injury or death. This signal word is limited to the most extreme situations.



**WARNING** - Indicates a situation which, if not avoided, could result in serious injury or death.



**CAUTION** - Indicates a situation which, if not avoided, can result in damage to the machine.

		<p><b>DANGER - Watch Out for Pinch Points. Stay clear of moving parts.</b>            Do Not Stand Near any Part of a Rotating Drum or Drum Holder. Operator should remain directly in front of the control station while operating the Tumbler. Morse Drum Tumblers comply with OSHA when installed in accordance with OSHA subpart O, 1910.212 - "General requirements for all machines." "Revolving drums, barrels, and containers shall be guarded by an enclosure which is interlocked with the drive mechanism, so that the barrel, drum, or container cannot revolve unless the guard enclosure is in place." A safety enclosure and interlock is included with the Morse CE marked drum tumbler.</p>
	<p><b>DANGER</b> - Live electrical parts could cause death or shock. Lock out and tag out before working on any electrical wiring. Only qualified electricians are to do electrical work. Do not remove or install any parts while housing is connected to power.</p>	
	<p><b>WARNING</b> - The 309-CE Series is designed to rotate a steel, plastic or fiber drum weighing up to 363 kg (800 Lb.), ranging from 45.7 cm to 59.7 cm (18" to 23.5") in diameter and from 74 cm to 94 cm (29" to 37") in height. DO NOT attempt to handle any other type of drum or object. DO NOT exceed the weight capacity of 363 kg (800 Lb.).</p>	
	<p><b>WARNING</b> - Level Floors Only. For operation only on clean, level floors of suitable bearing capacity. Do not use on sloped surfaces, ramps, irregular or debris strewn floors.</p>	
	<p><b>WARNING</b> - Properly Mount to Floor. Do Not put into service without proper floor mounting and leveling. Use the four mounting holes in each corner of the base to anchor to floor.</p>	
	<p><b>WARNING</b> - Do Not Modify the Unit. Under no circumstances should any modifications be made to the Morse machinery without factory authorization. Any modifications may void the warranty. This machine was designed to perform a specific job, and alterations may result in injury to operator or machine.</p>	
	<p><b>WARNING</b> - No Loose Fitting Clothing. Wear close-fitting clothing and safety equipment appropriate to the job. Loose fitting clothing may become caught on the machinery and cause severe personal injury.</p>	
	<p><b>CAUTION</b> - Wear safety shoes with non-slip soles and hard toe protection.</p>	
	<p><b>CAUTION</b> - DO NOT allow drum to impact on floor, ground, etc.</p>	
	<p><b>WARNING</b> - This product can expose you to chemicals including barium sulfate, cobalt, titanium dioxide, and 2-methylimidazole, which are known to the State of California to cause cancer, and bisphenol-A, which is known to the State of California to cause birth defects or other reproductive harm. For more information go to <a href="http://www.P65Warnings.ca.gov">www.P65Warnings.ca.gov</a></p>	

## Machine Description

The Morse model 309-3-50-CE Drum Tumbler is designed to receive an upright steel, plastic or fiber drum and rotate the drum "corner-over-corner" from 2 to 20 RPM, based on a 50Hz, 1465 RPM AC motor. The maximum full drum capacity is 363 kg (800 Lb.). Capacity is derated to 181 kg (400 Lb.) for a half-full drum. Half-full capacity is an indication of the capacity for tilting a bottom-heavy drum. A partially full drum with an unbalanced and shifting load is harder to tilt than a full drum.



## Controls

The Morse model 309-3-50-ce control package includes the following features: a start & stop button along with a red emergency stop button. A lockable main disconnect to shut off and lock out power to the unit. A 24V DC control supply. Wire terminals for external connection of a safety interlock switch. A timer for controlling the amount of tumbling time, from a few seconds to multiple hours. A variable speed knob for controlling drum rotation from 2 to 20 rpm.

## Drum Holder

The drum holder is the component on the Drum Tumbler that securely holds the drum for rotating. The drum holder features the web strap and ratchet mechanism for tightening the drum at the middle and two top clamps for holding the drum end-to-end.

## Installation

Install all Morse Drum Tumblers in accordance with CE requirements for enclosure and safety interlock, etc. Drum Tumbler must automatically turn off when enclosure door is opened.

## Machine Unpacking

Carefully remove the top and sides of the crate covering the machine so as not to damage painted surfaces or electrical components. Inspect the machine for visible damage. If damage is noted, follow receiving procedure. Remove the (4) lag screws connecting the machine base to the pallet.

Remove machine from pallet (Figure 3.1) by lifting 7.62 cm (3") diameter drum holder shaft. Attach a strap to an overhead crane and raise slowly, as the machine will have a tendency to tilt.

## Installation / Assembly Instructions

- The tumbler base has four holes spaced 68.6 cm wide x 113.7cm long (27" x 44.75"). Morse recommends the tumbler be secured to the floor using four 1.58 cm diameter x 7.62 cm long (5/8" x 3") lag bolts (not included).
- Secure control mast to floor outside of safety enclosure using four .952 cm diameter x 7.62 cm long (3/8" x 3") stud anchors (not included).
- Install enclosure and safety interlock around drum tumbler (see enclosure instructions). Drum tumbler must automatically turn off when enclosure door is opened.
- Control Station - Making Connections (see control box wiring diagram):
  - Drum Tumbler is shipped with motor wired to control box. An electrician needs to install **3PH/400V** power supply to control box. All wiring must be to national and local codes. With power to circuit locked out and tagged out, connect control panel to plant circuit.
  - Route wiring from interlock switch to control box. Replace jumper wire with wires from interlock switch.
  - Close the control panel before powering up.



**Figure 3.1**

## Important

When loading, unloading, operating, or maintaining your MORSE drum tumbler, always use care and good judgment. Maintain secure footing and a firm hold. Keep hands and loose clothing away from all moving parts. Never allow anyone to be below any part of a raised drum handler or drum. Read operating instructions and review the pictures in the sales brochure before operation.

## Operating Instructions

### Loading a Drum

1. Swing ratchet clear of drum holder opening. Loosen top clamps to full open position (see figure 4.1).
2. A variety of drum handling methods can be used to set a drum into the drum holder. Ensure that drum is fully seated against the back of drum holder (see figure 4.2).
3. Drape web strap across face of drum. Thread strap through slot in ratchet. Operate ratchet to tighten strap around drum (see figure 4.3).
4. Turn top clamps until they tighten against top of drum (see figure 4.4).

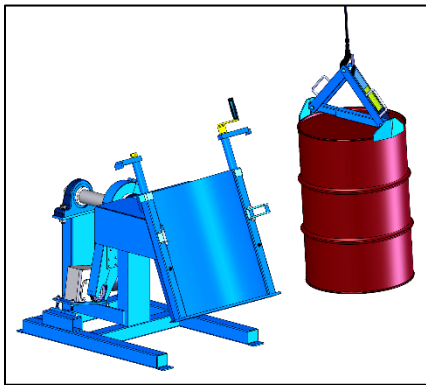

**Figure 4.1** load drum with hoist using appropriate drum lifting equipment, such as model 92 Drum Lifter

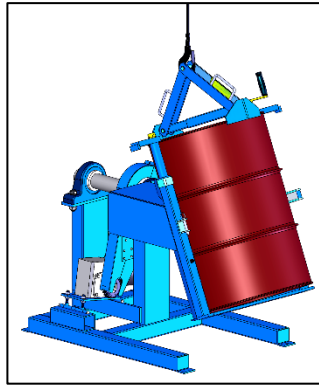

**Figure 4.2** Guide drum so it tilts back and seats into drum holder as it is lowered



**Figure 4.3** Drape web strap across face of drum. Thread strap through slot in ratchet. Operate ratchet to tighten strap around drum.



**Figure 4.4** Turn top clamps until they tighten against top of drum. Remove hand crank BEFORE rotating drum.

## Rotating a Drum

1. After ensuring drum is securely fastened in drum holder, close guard enclosure to engage interlock switch.
2. Power up control panel. Press green START button.
3. Set timer to rotate drum for desired time. Use buttons to adjust seconds, minutes & hours.
4. Use variable speed knob to control drum rotation from 2 to 20 rpm.
5. Press black STOP button to stop tumbling. A red EMERGENCY STOP button is included in case of emergency. Push to activate and twist to release.

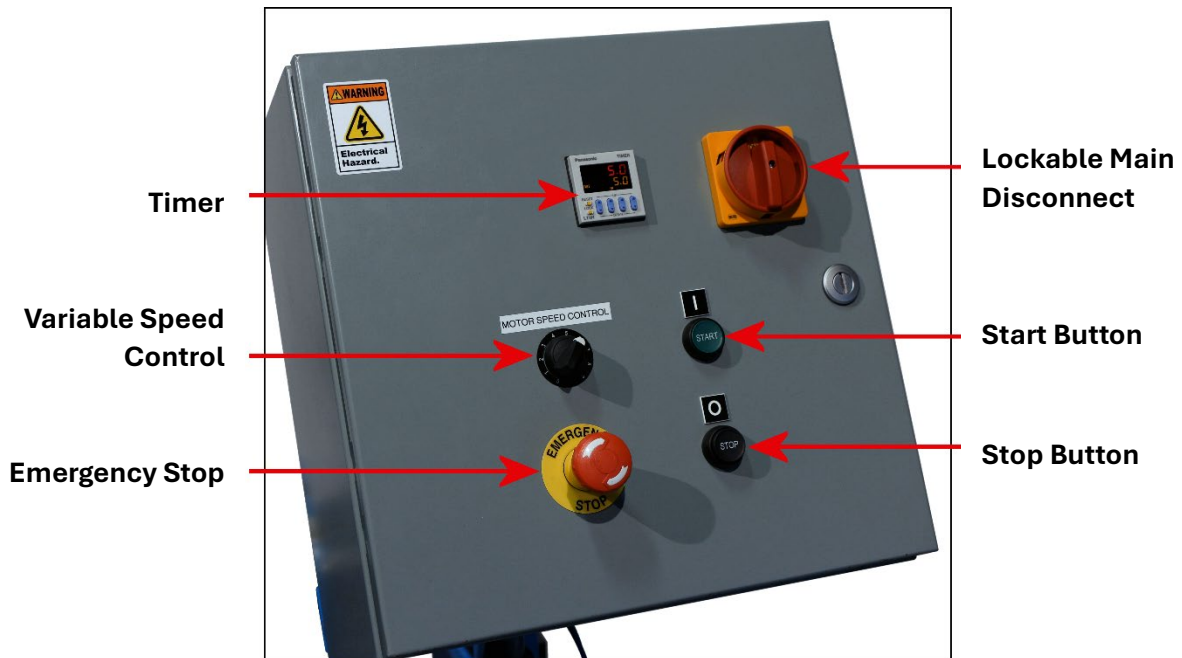

Figure 5.1

## Unloading a Drum

Jog as required to get drum holder in upright position.

1. Squeeze ratchet release lever and open all the way to unlock, then release the tension on the strap. Allow enough slack in the strap in order to remove from ratchet.
2. Loosen top clamps and swing clear of drum.
3. Remove drum with appropriate drum handling equipment.

## Preventative Maintenance

Periodic inspection for the general condition of structural and mechanical components is imperative for safe and efficient operation. Tighten, adjust or replace parts as necessary to prevent failure and maintain proper function.

### Monthly

Inspect all moving parts, framework, and floor mounting fasteners for signs of wear, fatigue, or loosening.

The web strap should be removed from service and replaced if any of the following are visible:

- Acid or caustic damage
- Melting or charring of any part of the strap
- Holes, tears, cuts, snags or embedded particles
- Broken or worn stitching in load bearing splices
- Excessive abrasive wear

Replace any parts that show signs of wear.

### Every 6 to 12 Months in Ordinary Environment (monthly in dirty conditions)

Inspect oil level in gear box / speed reducer and fill with high quality, synthetic lubricant for gears if necessary. Use Enduratex EP 460 Synthetic oil or equivalent. The speed reducer has been filled and tested prior to shipment. After operating a new machine for 1500 hours, the housing should be thoroughly flushed out and new oil added to fill the housing to the oil level plug. The oil should be changed every 5000 operating hours thereafter or more often if operating conditions cause condensation of moisture resulting in sludge formation inside housing.

Lubricate all moving parts including: bearings, ratchet, drive chain and clamp rods.

- Pillow Block Bearings: Grease every 6-12 months in ordinary environment, grease monthly in dirty conditions. See [Bearing Lubrication Sheet](#) for grease types and fill amounts.
- Drive chain: Grease every 6-12 months with multiservice lubricant (i.e. Whitmore's [Surtac® 2000 HD](#))
- Clamp Rods: Grease every 6-12 months with multiservice lubricant (i.e. Whitmore's [Surtac® 2000 HD](#))

<b>309-3-50-CE Specification Sheet</b>	
<b>Capacity:</b> Full Drum 1/2-Full Drum	363 kg (800 Lb.) 182 kg (400 Lb.)
<b>Drum Holder Specs:</b> Drum Diameter Drum Height	45.72 cm to 59.69 cm (18" to 23.5") 73.66 cm to 93.98 cm (29" to 37")
<b>Drum RPM:</b>	2 to 20
<b>Machine Height:</b>	126.37 cm (49.75")
<b>Machine Floor Space:</b>	127 cm Long x 76.2 cm Wide (50" Long x 30" Wide)
<b>Enclosure Height:</b>	160.66 cm (63.25")
<b>Enclosure Floor Space:</b>	193.04 cm Long x 132.08 cm Wide (76" Long x 52" Wide)
<b>Shipping Weight:</b>	599 kg (1320 Lb.)
<b>AC Motor Specs for Model 309-3-50-CE</b> 1HP 3PH 1465 RPM 50HZ 56C TEFC	<b>VOLTS (AMP DRAW)</b> 380V (1.53 Amps)