

Contents

	Page
Receiving Procedures.	1
Warranty.	1
Safety Information.	1 - 2
Machine Description.	3 - 4
Operating Instructions.	4 - 5
Maintenance.	5

Operator's Manual
for Morse Hydra-Lift Drum Karrier

Model 400A-96-125
Serial Number 0409 to 1110 (MMYY)

Receiving Procedures

Every Morse drum handler is inspected prior to shipping. However, damage may be incurred during transit.

- Check for visible damage. If you choose to accept damaged freight, always sign noting the damage on the **BILL OF LADING**.
- Document the damage and have the truck driver sign. We recommend keeping a digital camera at your receiving dock for this purpose.
- Open packages expeditiously to check the condition of the goods. There is only a 24 hour window to notify the carrier of any concealed damage.
- **IMMEDIATELY REPORT ALL DAMAGE TO THE SHIPPING COMPANY!** Then you may contact Morse for assistance with your freight claim.
- Morse Manufacturing will not be held responsible for any damaged freight that is not signed for as damaged.

Delivery to non-business addresses without a loading dock result in additional freight charges. Residential delivery fees, inside delivery fees, re-delivery charges, and lift gate services will be added by the truck line, and are non-negotiable.

Limited 2 Year Warranty

Morse drum handling equipment is guaranteed against defects in workmanship or materials for **TWO YEARS** when used properly within its rated capacity. Warranty does not cover wear from normal use or damage from accident or abuse. Motors and other purchased parts carry the warranties of their manufacturers.

For warranty claims, contact your Morse Dealer to obtain a return authorization number, and for return freight advice. Return freight must be prepaid.

In all instances, liability is limited to the purchase price paid or to repairing or replacing the product. Customer assumes liability for any modifications, unauthorized repairs or parts substitution.

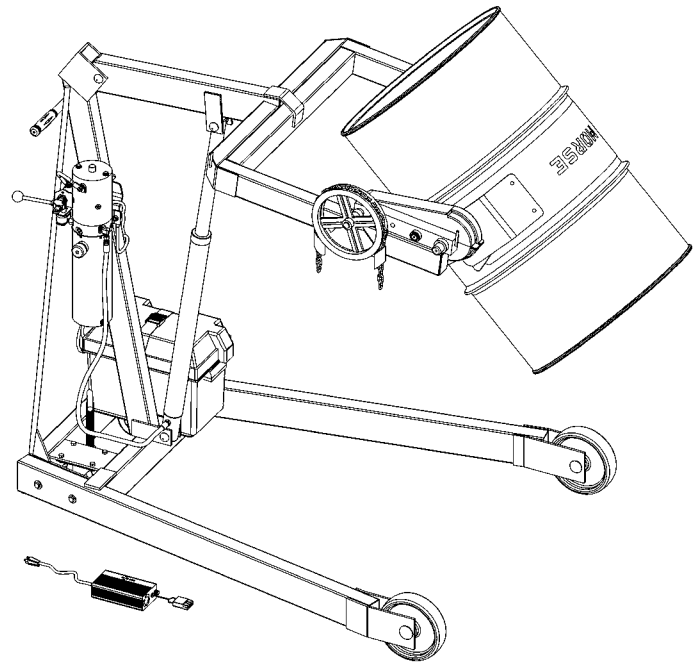

Safety Information

While Morse Manufacturing Co. drum handling equipment is engineered for safety and efficiency, a high degree of responsibility must be placed upon the machine operator to follow safe practices, based primarily on common sense, upon which true safety depends.

Failure to follow the safety precautions in this manual can result in personal injury or property damage. Observe the same precautions as with similar machinery where carelessness in operating or maintenance is hazardous to personnel. Carefully read the safety precautions below and throughout this manual.

Operator's Manual for Morse Hydra-Lift Karrier Model 400A-96-125 Serial Number 0409 to 1110 (MMYY)

Safety Information (continued)



DANGER - Indicates a situation which, if not avoided, *will* result in serious injury or death. This signal word is limited to the most extreme situations.



WARNING - Indicates a situation which, if not avoided, *could* result in serious injury or death.



CAUTION - Indicates a situation which, if not avoided, can result in damage to the machine.



CAUTION – Do Not Transport with Drum Raised

ALWAYS LOWER THE DRUM HOLDER TO LOWEST POSITION BEFORE TRANSPORTING. The unit can become unstable when transporting with a raised load.



DANGER - Stay Clear of Power Lines

KEEP WELL CLEAR OF POWER LINES. Never approach a power line. Current in a high voltage line may arc some distance from the wire to the steel framed, grounded machine.



WARNING

The Hydra-Lift Karrier is designed to handle one drum of the types listed at the top of page 3, under **2. Machine Description**. *DO NOT* attempt to handle any other type of drum or object. *DO NOT* exceed the weight capacity of 800 Lb.



WARNING - Level Floors Only

For operation only on clean, level floors of suitable bearing capacity. Do not use on sloped surfaces, ramps, irregular or debris strewn floors.



WARNING - Do Not Modify the Unit

Under no circumstances should any modifications be made to the Morse machinery without factory authorization. Any modifications may void the warranty. This machine was designed to perform a specific job and alterations may result in injury to operator or machine.



WARNING - No Loose Fitting Clothing

Wear close-fitting clothing and safety equipment appropriate to the job. Loose fitting clothing may become caught on the machinery and cause severe personal injury.



WARNING - Hydraulic Fluid Under Pressure Can Be Hazardous

Escaping hydraulic fluid under pressure can penetrate the skin, causing serious injury. Avoid the hazard by relieving pressure before disconnecting hydraulic lines. Keep hands and body away from pinholes and nozzles, which eject fluid under high pressure. Use a piece of cardboard to search for leaks. If an accident occurs, see a doctor immediately and inform them of the nature of the accident.



CAUTION - Wear Safety Shoes

Wear safety shoes with non-slip soles and hard toe protection.

**Operator's Manual for Morse Hydra-Lift Karrier Model 400A-96-125
Serial Number 0409 to 1110 (MMYY)**

Machine Description

The Model 400A-96-125 Hydra-Lift Karrier will pour a drum up to 96" high, measured from the floor to the lowest point of a horizontal drum. It is designed to lift, transport, and dispense a 55-gallon steel or fiber drum 22" to 23.5" in diameter.

The maximum full-drum capacity is 800 Lb. The capacity is derated to 500 Lb. for a half-full drum. The half-full rating is based on the tilt mechanism's capacity for handling an unbalanced bottom-heavy drum.

Options

- A smaller diameter drum can be handled with the correct size 55/30 Series Diameter Adaptor installed (see [Diameter Adaptor literature](#)).
- The **Bracket Assembly** (Part # 4556-P) is **required** to handle a plastic drum without a top rim (see figure 2.1). It is also recommended to more securely handle a fiber drum. You can use the Bracket Assembly with a 55-gallon plastic, steel or fiber drum. The brace at top and bottom of the drum prevent it from slipping lengthways through the drum holder. It adjusts for a drum 31" to 39" tall.
- The **Top Rim Clamp** (Part # 4560-P) grips the upper rim of your drum to prevent it from slipping through the drum holder (see figure 2.2). To handle a 55-gallon plastic drum with top rim, you **must** install either the Bracket Assembly or the Top Rim Clamp. You can use the Top Rim Clamp with a 55-gallon plastic, steel or fiber drum with suitable top rim.

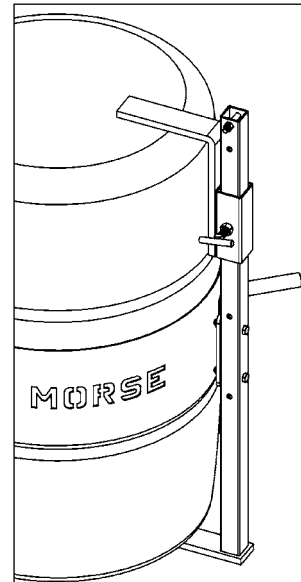

Figure 2.1
Plastic drum being lifted with part number 4556-P Bracket Assembly installed.

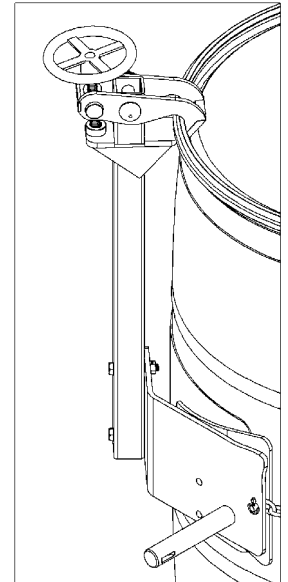

Figure 2.2
Plastic drum being lifted with part number 4560-P Top Rim Clamp Assembly installed.

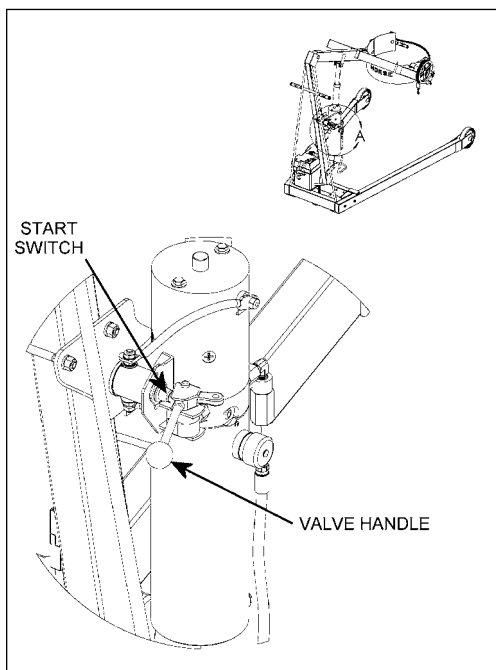

Figure 2.3

Controls

The Morse Hydra-Lift Karrier is manually propelled and steered. The drum lift is powered by a 12V DC motor. There are two functions for the operator to control (Figure 2.3):

1. **LIFT and Lower Function** to raise and lower the drum
 - Push and hold the valve handle in against the start switch.
 - Release the handle when the drum is at the desired height.
 - To lower the drum: Pull and hold the valve handle out away from the start switch.
2. **TILT Function** to tilt the drum
 - Pull down on one side of chain, rotating drum to angle required for pouring.
 - For best control of drum pouring angle, pay out one side of the chain loop while pulling in the other side. This helps you to hold back the drum rotation if the contents of the drum shift.
 - The pull chain pin on the corner of the overhead assembly can be used to prevent drum rotation. Simply "tie-off" the chain by engaging in into the pin.
 - If the drum handler is equipped with the MORStop Tilt-Brake, there is no need to hold tension on both sides of the chain loop. Braking is immediate and self-actuating, without additional steps by the operator. To add the MORStop Tilt-Brake to your drum handler, order part # 3900-P for a field installation kit.

Operator's Manual for Morse Hydra-Lift Karrier Model 400A-96-125 Serial Number 0409 to 1110 (MMYY)



WARNING - Watch Out for Pinch Points

Stay clear of moving parts. Operator should remain behind the push handle during the lift operation.

Floor Lock

The screw-down floor lock is located on the base of the tower (figure 3.1). Turning the floor lock clockwise until it locks in the down position activates the floor lock. When the floor lock is activated it prevents unwanted free wheeling of the unit. Floor conditions determine the effectiveness of the floor lock. The operator should verify its holding action before depending on it to hold.

MORcinch Drum Holder Assembly

The drum holder assembly (or "saddle assembly") is the component on the Hydra-Lift Karrier that is intended to hold the drum. The MORcinch drum holder assembly is designed to secure a standard ribbed 55-gallon steel drum around its middle using a cinch chain and ratchet tightening system. The MORcinch drum holder accepts accessories for handling a plastic drum, a fiber drum, or smaller diameter drums (see Options on pg. 3).

Operating Instructions

- 1.) Push the Hydra-Lift Karrier to the drum.
- 2.) Using the "LIFT" control as described in "**Machine Description - Controls**" (page 3), position the drum holder assembly with the back band at the middle of the drum. (Figure 3.1). With the ratchet plate swung open and the cinch chain hanging from the chain hook, push the unit until the back band rests firmly against the drum. Some adjustment to the tilt angle of the saddle may be necessary to ensure band fits flush on the drum.
- 3.) **Attaching the drum:**
Drape the chain across the front of the drum and engage a link into the slot in the ratchet (Figure 3.2). Turn the ratchet clockwise to tighten chain. If ratchet turns until the pawl is beyond the last ratchet tooth, turn the ratchet back and slide the next link into the ratchet slot and try tightening again. The chain must be held tightly against the drum with the pawl engaged securely in the ratchet teeth.
- 4.) Operate the lift function to lift drum clear of floor. Roll to dispensing location. NOTE: Do not allow the drum to impact on floor, pouring station, etc. or a spill or damage could occur.

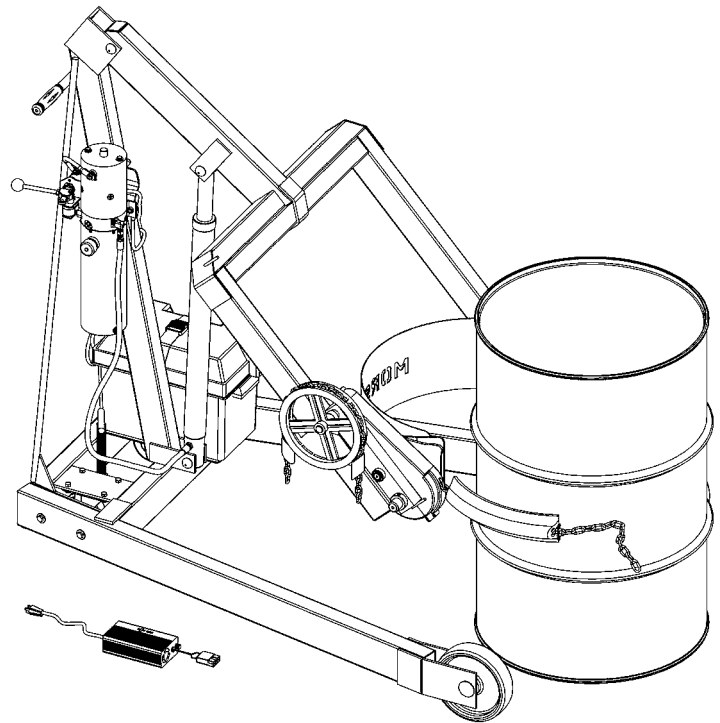

Figure 3.1

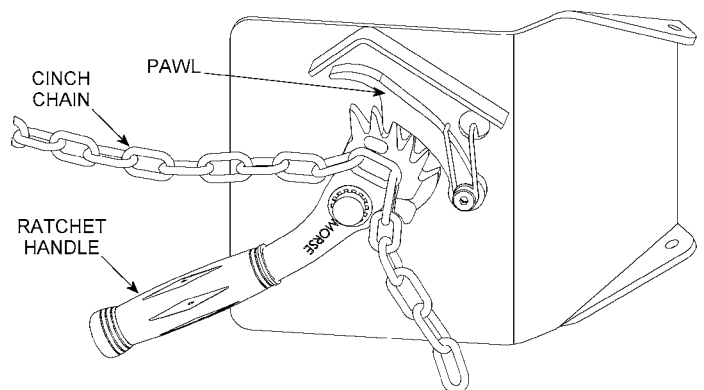

Figure 3.2

Operator's Manual for Morse Hydra-Lift Karrier Model 400A-96-125
Serial Number 0409 to 1110 (MMYY)



CAUTION – Do Not Transport with Drum Raised

ALWAYS LOWER THE DRUM HOLDER TO LOWEST POSITION BEFORE TRANSPORTING. The unit can become unstable when transporting with a raised load.

- 5.) Lift drum to desired pouring height. Operate the tilt control as described in “**Machine Description - Controls**” (page 3) to adjust the drum attitude. This is especially important when lifting an open drum. The floor lock should be engaged while dispensing / draining.
- 6.) When dispensing is complete, tilt drum back to upright position. Disengage the floor lock and lower the drum to transporting height; about 6” off the floor.



WARNING - Stay Clear of Raised Drum

NEVER allow anyone to be below any part of a raised drum handler or drum. Remain behind the push handle while handling a drum.



WARNING – Do NOT Disengage the Cinch Chain When Drum is off the Ground

When the drum is in the upright position, lower the drum to the floor before releasing the cinch chain.

- 7.) Push the unit to the drum storage area and lower to the floor in an upright position. Release the cinch chain from the ratchet by applying pressure to the ratchet handle in a clockwise direction with one hand and opening the pawl to free the ratchet with the other hand. Remove the cinch chain link from the ratchet.

Maintenance

Periodic inspection for the general condition of structural and mechanical components is imperative for safe and efficient operation.

Periodically inspect all moving parts, framework, and contact areas for signs of wear, fatigue, or loosening. Tighten, adjust, or replace parts as necessary to prevent failure and maintain proper function.

Inspect the hydraulic system for oil drips, hose damage, or other signs of wear. Inspect the level and condition of the hydraulic fluid. Replace any parts that show signs of wear.

Grease wheel bearings periodically. Oil or grease all moving parts including: the three clevis pins and the surfaces of the boom which contact the inside of the mast cap, the hinge pin, the gears and sprockets in the tilt drive, and the ratchet and pawl.

Worn or damaged parts must be properly replaced with the correct, genuine Morse parts.

Hydraulic pump is shipped filled with Noco Premium plus automatic transmission fluid d/m. Material safety data sheet (msds) is available online. Change oil yearly, sooner depending on dirty conditions or outdoor use. Replace oil with Mobil dte 24 or equivalent for indoor use (Mobil dte 13 for outdoor use).