

**CONTENTS**

	Page
Receiving Procedures. . . . .	1
Warranty. . . . .	1
Safety Information. . . . .	1 - 2
Machine Description. . . . .	3 - 4
START-UP Procedure. . . . .	4
Operating Instructions. . . . .	5
Maintenance. . . . .	5

**Operator's Manual**  
**for Morse Vertical-Lift Drum Pourer**  
**Model 510**

Serial Number 249855 to \_\_\_\_\_

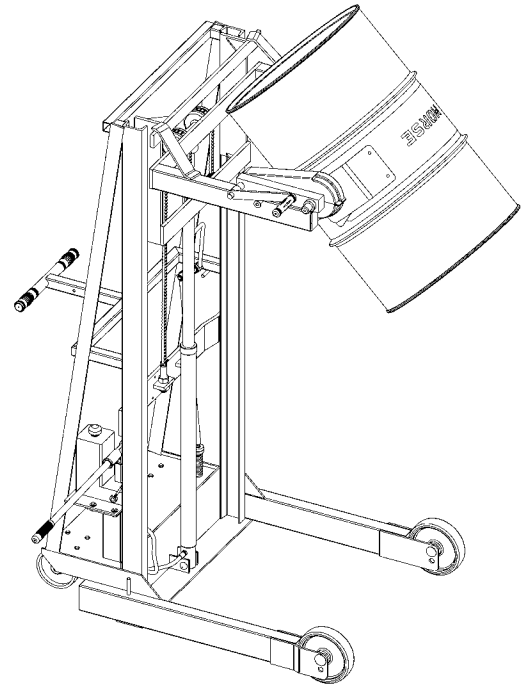

**Receiving Procedures**

Every Morse drum handler is inspected prior to shipping. However, damage may be incurred during transit.

- Check for visible damage. If you choose to accept damaged freight, always sign noting the damage on the **Bill of Lading**.
- Document the damage and have the truck driver sign. We recommend keeping a digital camera at your receiving dock for this purpose.
- Open packages expeditiously to check the condition of the goods. There is only a 24 hour window to notify the carrier of any concealed damage.
- Immediately **report all damage to the shipping company!** Then you may contact Morse for assistance with your freight claim.
- Morse Manufacturing will not be held responsible for any damaged freight that is not signed for as damaged.

**Machine Unpacking**

Remove machine from pallet by lifting from the square tubing at the top of the unit. Insert a strap or chain through the tubing and make a loop to lift by. Attach loop to an overhead crane and raise slowly.

**Limited 2 Year Warranty**

Morse drum handling equipment is guaranteed against defects in workmanship or materials for two years when used properly within its rated capacity. Warranty does not cover wear from normal use or damage from accident or abuse. Motors and other purchased parts carry the warranties of their manufacturers.

For warranty claims, contact your Morse Dealer to obtain a return authorization number, and for return freight advice. Return freight must be prepaid.

In all instances, liability is limited to the purchase price paid or to repairing or replacing the product. Customer assumes liability for any modifications, unauthorized repairs or parts substitution.

**Safety Information**

While Morse Manufacturing Co. drum handling equipment is engineered for safety and efficiency, a high degree of responsibility must be placed upon the machine operator to follow safe practices, based primarily on common sense, upon which true safety depends.

Failure to follow the safety precautions in this manual can result in personal injury or property damage. Observe the same precautions as with similar machinery where carelessness in operating or maintenance is hazardous to personnel. Carefully read the safety precautions below and throughout this manual.

Review the Material Safety Data Sheet(s) for the material(s) in the drum(s) and take all necessary precautions. Safety shoes, work gloves, hard hat and other personal protective devices are recommended.

Prior to initial use, inspect all moving parts and test rotation of drum holder. Perform necessary load test, inspections, operator training, etc.



[morsedrum.com](http://morsedrum.com)



[service@morsedrum.com](mailto:service@morsedrum.com)



(315) 437-8475





103 Kuhn Rd.  
Syracuse, NY, 13208 USA











**Operator's Manual for Morse Vertical-Lift Drum Pourer Model 510**  
**Serial Number 249855 to \_\_\_\_\_**

**Safety Information** (continued)

 **DANGER** - Indicates a situation which, if not avoided, *will* result in serious injury or death. This signal word is limited to the most extreme situations.

 **WARNING** - Indicates a situation which, if not avoided, *could* result in serious injury or death.

 **CAUTION** - Indicates a situation which, if not avoided, can result in damage to the machine.

-   **CAUTION - Do NOT transport with drum raised.**  
Always lower the drum holder to lowest position before transporting.
-  **DANGER - Stay well clear of power lines.**  
Never approach a power line. Current in a high voltage line may arc some distance from the wire to the steel framed, grounded machine.
-  **WARNING** - The Vertical-Lift Drum Pourer is designed to handle one drum of the types listed at the top of page 3 - Machine Description. DO NOT attempt to handle any other type of drum or object. DO NOT exceed the weight capacity of 800 Lb. (363 kg).
-  **WARNING - Level floors only.**  
For operation only on clean, level floors of suitable bearing capacity. Do not use on sloped surfaces, ramps, irregular or debris strewn floors.
-  **WARNING - Do NOT modify the unit.**  
Under no circumstances should any modifications be made to the Morse machinery without factory authorization. Any modifications may void the warranty. This machine was designed to perform a specific job and alterations may result in injury to operator or machine.
-  **WARNING - No loose fitting clothing.**  
Wear close-fitting clothing and safety equipment appropriate to the job. Loose fitting clothing may become caught on the machinery and cause severe personal injury.
-  **WARNING - Hydraulic fluid under pressure can be hazardous.**  
Escaping hydraulic fluid under pressure can penetrate the skin, causing serious injury. Avoid the hazard by relieving pressure before disconnecting hydraulic lines. Keep hands and body away from pinholes and nozzles, which eject fluid under high pressure. Use a piece of cardboard to search for leaks. If an accident occurs, see a doctor immediately and inform them of the nature of the accident.
-  **CAUTION - Wear safety shoes.** - Wear safety shoes with non-slip soles and hard toe protection.
-  **WARNING:** This product can expose you to chemicals including barium sulfate, cobalt, titanium dioxide, and 2-methylimidazole, which are known to the State of California to cause cancer, and bisphenol-A, which is known to the State of California to cause birth defects or other reproductive harm.  
For more information go to [www.P65Warnings.ca.gov](http://www.P65Warnings.ca.gov)

**Operator's Manual for Morse Vertical-Lift Drum Pourer Model 510**  
**Serial Number 249855 to \_\_\_\_\_**

**Machine Description**

The Model 510 Vertical-Lift Drum Pourer will pour a drum at up to 60" (152 cm) high, measured from the floor to the lowest point of a horizontal drum. It is designed to lift, transport, and dispense a ribbed 55-gallon (210 liter) steel drum 22.5" (56 cm) in diameter, as well as a fiber drum between 22" and 23.5" (56 to 59.7 cm) in diameter.

Maximum full-drum capacity is 800 Lb. (363 kg). Capacity is derated to 500 Lb. (227 kg) for a half-full drum. Half-full rating is based on the tilt mechanism's capacity for handling an unbalanced bottom-heavy drum.

**MORSE**  
Mfg. Co., Inc.  
E. Syracuse, NY

**800**  
( 363 kg )

**Lb. Max.**  
Capacity

Made in U.S.A.

**ACCESSORIES**

**55/30 Series Diameter Adapters** for drum with diameter smaller than 22" (56 cm). To handle a smaller drum, insert the correct size Diameter Adapter into the standard drum holder. See Diameter Adapter info at: <https://morsedrum.com/products/diameter-adapters>

ONLY Diameter Adapters for drum with 17.5" (44.5 cm) diameter or smaller have integrated brackets to prevent drum slipping length-ways.

**NOTE:** For 30-gallon (114 Liter) PLASTIC drum, insert Diameter Adapter; **AND** install Bracket or Top Rim Clamp to prevent drum slipping.

**IMPORTANT:** To prevent 30 to 55 gallon (114 to 210 L) size plastic drum from slipping, you **MUST** install either Top Rim Clamp Kit or Bracket Assembly Kit.

- 1. Bracket Assembly Kit # 4556-P** is required to handle a RIMLESS plastic drum (figure 2.1), and is also recommended for a fiber drum. The Bracket adjusts for a 31" to 39" (79 to 99 cm) tall drum. You can also handle a rimmed drum with the Bracket installed.
- 2. Top Rim Clamp Kit # 4560B-P** to handle a RIMMED plastic drum (figure 2.2). Install the Top Rim Clamp Kit to handle a RIMMED plastic, steel or fiber drum with suitable top rim.

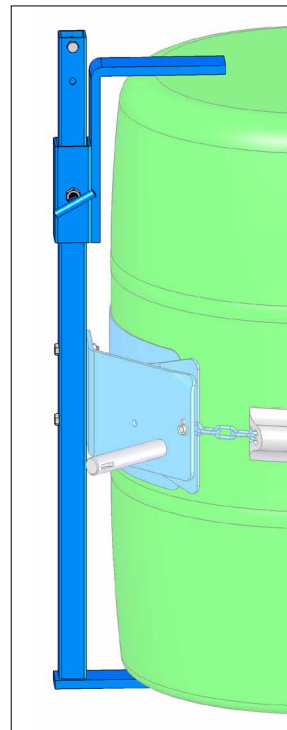

**Figure 2.1**

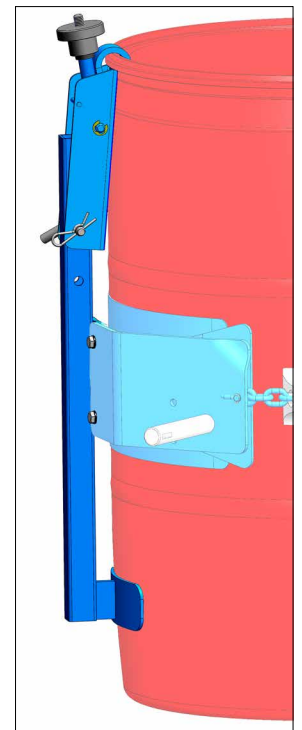

**Figure 2.2**

**Kit # 4556-P**  
Install Bracket Assembly Kit to handle RIMLESS or RIMMED plastic drum

**Kit # 4560-P**  
Install Top Rim Clamp Kit to handle RIMMED plastic drum

**MORStop™ Tilt-Brake**  
**Kit # 3900-P**

Automatically holds drum tilt angle until you move it.

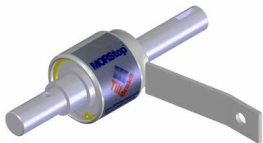

Kit for customer to install on EXISTING manual tilt drum handler.

**Hand Wheel**  
**Kit # 2690-P**

16" (40.6 cm) diameter Hand Wheel with speed knob. Replaces standard Pull Chain to turn drum.



Kit for customer to install on EXISTING manual tilt drum handler.

**Operator's Manual for Morse Vertical-Lift Drum Pourer Model 510**  
**Serial Number 249855 to \_\_\_\_\_**

**Controls**

The Morse Vertical-Lift Drum Pourer is manually propelled and steered.

There are two functions for the operator to control:

1. "LIFT" and lower function for vertical positioning drum
2. "TILT" function to control the degree of rotation drum

**1. LIFT and Lower Function (Figure 3.1)**

To raise drum

- a. Insert pump lever handle into pump socket.
- b. With release valve closed, begin to pump lever handle. Drum will lift.

To lower the drum

- a. Open release valve slowly, a part of a turn. Allow drum to descend at controlled rate. Valve may be reclosed to hold drum at any height.

**2. TILT Function**

To tilt drum

- a. Turn hand crank to turn drum.
- b. Before releasing grip on hand crank, pull out crank stop pin to block hand crank from spinning freely.
- c. If drum handler is equipped with MORStop Tilt-Brake, there is no need to use stop pin. Braking is immediate and self-actuating, without additional steps by operator.

Note: To add MORStop Tilt-Brake to existing drum handler, order Kit 3900-P.

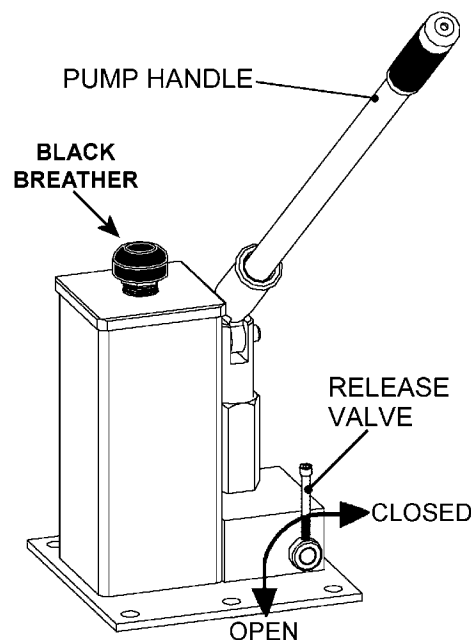

**Figure 3.1**

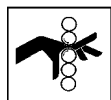

**WARNING - Watch out for pinch points**

Stay clear of moving parts. Operator should remain behind the push handle during the lift operation.

**Floor Lock**

Floor lock handle is located on left side of push handle. Pulling floor lock handle toward operator until it locks in down position activates the floor lock. When floor lock is activated it prevents unwanted free wheeling of unit. Floor conditions determine effectiveness of floor lock. Operator should verify its holding action before depending on it to hold.

**Drum Holder Assembly**

MORCINCH™ Drum Holder assembly ("saddle") is the component on Vertical-Lift Drum Pourer intended to hold drum. Carriage assembly moves vertically along mast to position drum holder assembly at correct height to secure drum around it's middle using cinch chain and ratchet tightening system. The MORCINCH™ Drum Holder accepts accessories to handle plastic drum, fiber drum, or a smaller diameter drum.

**- - IMPORTANT - -**

**START-UP Procedure**

Machine is shipped with hydraulic fluid.

BEFORE operation, REMOVE the **RED** shipping plug from the hydraulic reservoir. REPLACE with supplied **BLACK** breather.

Insert pump handle into pump socket.

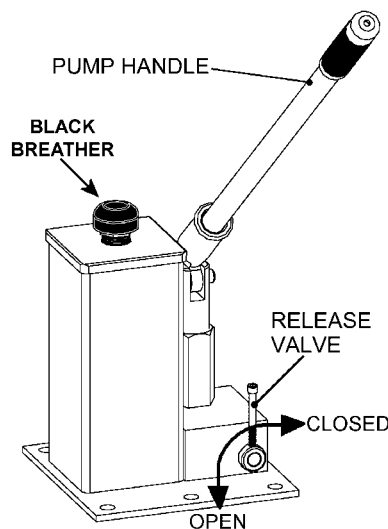

**Operator's Manual for Morse Vertical-Lift Drum Pourer Model 510**  
Serial Number 249855 to \_\_\_\_\_

**Operating Instructions**

1. Push the Vertical-Lift Drum Pourer to the drum.
2. Using "LIFT" control as described in "Machine Description - Controls", position drum holder assembly with back band at middle of drum. With ratchet plate swung open and cinch chain hanging from chain hook, push unit until back band rests firmly against drum. Some adjustment to tilt angle of saddle may be necessary to ensure band fits flush on drum. Engage floor lock.
3. **Attaching drum:** Drape cinch chain across front of drum and engage chain link into notch in ratchet (Figure 3.2). Turn ratchet clockwise to tighten cinch chain. If ratchet turns until pawl is beyond last ratchet tooth, turn ratchet back and slide next link into ratchet notch and try tightening again. Cinch chain must be held tightly against drum with pawl engaged securely in ratchet teeth.
4. Operate lift function to lift drum clear of floor. Disengage floor lock. Roll to dispensing location. NOTE: Do not allow drum to impact on floor, pouring station, etc. or spill or damage could occur.

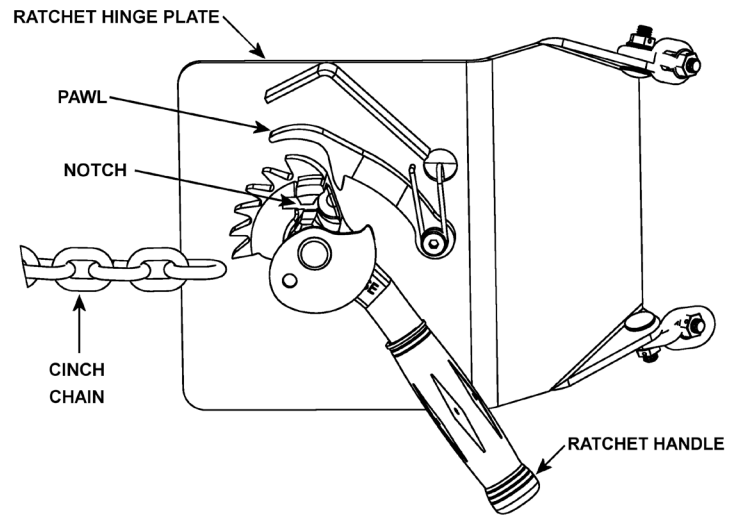

**Figure 3.2**



**CAUTION – Do NOT transport with drum raised.**

ALWAYS LOWER THE DRUM HOLDER TO LOWEST POSITION BEFORE TRANSPORTING. Unit can become unstable when transporting with raised load.

5. Lift drum to desired pouring height. Operate tilt control as described in "Machine Description - Controls" to adjust drum attitude. Floor lock should be engaged while dispensing / draining.
6. When dispensing is complete, tilt drum back to upright position. Disengage floor lock and lower drum to transporting height; about 6" (15 cm) off the floor.



**WARNING - Stay clear of raised drum**

NEVER allow anyone to be below any part of raised drum handler or drum. Remain behind push handle while handling drum.



**WARNING – Do NOT disengage cinch chain when drum is off the ground.**

When drum is in upright position, lower drum to the floor before releasing cinch chain.

7. Push unit to drum storage area and lower drum to the floor in upright position. Release cinch chain from ratchet by applying pressure to ratchet handle in clockwise direction with one hand and opening pawl to free ratchet with other hand. Remove cinch chain link from the ratchet.

**Maintenance**

1. Periodic inspection for the general condition of structural and mechanical components is imperative for safe and efficient operation.
2. Periodically inspect all moving parts, framework, drum holder and contact areas for signs of wear, fatigue, or loosening. Tighten, adjust, or replace parts as necessary to prevent failure and maintain proper function.
3. Inspect the hydraulic system for oil drips, hose damage, or other signs of wear. Inspect the level of the hydraulic fluid. Replace any parts that show signs of wear.
4. Grease wheel bearings periodically. Oil or grease all moving parts, including: gears and sprockets in tilt drive, and ratchet and pawl.
5. Worn or damaged parts must be properly replaced with the correct, genuine Morse parts.
6. Hydraulic pump is shipped filled with Noco Premium plus automatic transmission fluid d/m. Material safety data sheet (SDS / MSDS) is available online.  
Recommended oil is petroleum based Dexron III ATF or equivalent (non-synthetic). Change oil yearly.