

CONTENTS

- Receiving Procedures
- Warranty
- Safety Information
- Machine Description
- Assembly Instructions
- Operating Instructions
- Maintenance
- Calculate Lost Load

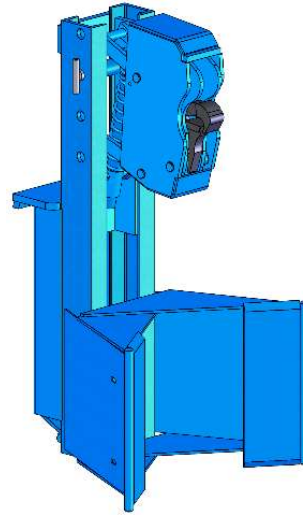

Receiving Procedures

Every Morse drum handler is inspected prior to shipping. However, damage may be incurred during transit.

- Check for visible damage. If you choose to accept damaged freight, always sign noting the damage on the **BILL OF LADING**.
- Document the damage and have the truck driver sign. We recommend keeping a digital camera at your receiving dock for this purpose.
- Open packages expeditiously to check the condition of the goods. There is only a 24 hour window to notify the carrier of any concealed damage.
- **IMMEDIATELY REPORT ALL DAMAGE TO THE SHIPPING COMPANY!** Then you may contact Morse for assistance with your freight claim.
- Morse Manufacturing will not be held responsible for any damaged freight that is not signed for as damaged.

Delivery to non-business addresses without a loading dock result in additional freight charges. Residential delivery fees, inside delivery fees, re-delivery charges, and lift gate services will be added by the truck line, and are non-negotiable.

Limited 2 Year Warranty

Morse drum handling equipment is guaranteed against defects in workmanship or materials for **TWO YEARS** when used properly within its rated capacity. The warranty does not cover wear from normal use or damage from accident or abuse. Motors and other purchased parts carry the warranties of their manufacturers.

For warranty claims, contact your Morse Dealer to obtain a return authorization number, and for return freight advice. Return freight must be prepaid.

In all instances, liability is limited to the purchase price paid or to repairing or replacing the product. Customer assumes liability for any modifications, unauthorized repairs or parts substitution.

Safety Information

While Morse Manufacturing Co. drum handling equipment is engineered for safety and efficiency, a high degree of responsibility must be placed upon the machine operator to follow safe practices, based primarily on common sense, upon which true safety depends.

Failure to follow the safety precautions in this manual can result in personal injury or property damage. Observe the same precautions as with similar machinery where carelessness in operating or maintenance is hazardous to personnel. Carefully read the safety precautions below and throughout this manual.









DANGER - Indicates a situation which, if not avoided, will result in serious injury or death. This signal word is limited to the most extreme situations.



WARNING - Indicates a situation which, if not avoided, could result in serious injury or death.



CAUTION - Indicates a situation which, if not avoided, can result in damage to the machine.

		<p>CAUTION – Do Not Transport with Drum Raised - ALWAYS LOWER THE DRUM HOLDER TO LOWEST POSITION BEFORE TRANSPORTING. The unit can become unstable when transporting with a raised load.</p>
		<p>WARNING - The MORSPEED™ is designed to handle one drum of the types listed in Machine Description. DO NOT attempt to handle any other type of drum or object. DO NOT exceed the weight capacity of 1500 Lb. (680 kg) per drum.</p>
		<p>WARNING - Do Not Modify the Unit - Under no circumstances should any modifications be made to the Morse machinery without factory authorization. Any modifications may void the warranty. This machine was designed to perform a specific job and alterations may result in injury to operator or machine.</p>
		<p>CAUTION - Wear Safety Shoes - Wear safety shoes with non-slip soles and hard toe protection.</p>
		<p>CAUTION: DO NOT allow drum to impact on floor, ground, or dumping station, etc.</p>
		<p>WARNING - This product can expose you to chemicals including barium sulfate, cobalt, titanium dioxide, and 2-methylimidazole, which are known to the State of California to cause cancer, and bisphenol-A, which is known to the State of California to cause birth defects or other reproductive harm. For more information go to www.P65Warnings.ca.gov</p>

Machine Description

The Model 287-2H Carriage Mount Drum Handler is designed to lift and transport:

- Rimmed steel, fiber or plastic drum.
- Maximum capacity is 1500 Lb. (680 kg) per drum.
- Requires a minimum of 350 Lb. (159 kg) per drum to begin the gripping action.
- Drum height must be 24" (61 cm) or taller.
- Works with any diameter drum.
- Can be used with a straight walled or damaged drum.



Options

Belted Backrest (part number 2523-P) pad equips *MORSPEED™* forklift attachment with a 12" (30.5 cm) wide fabric belt. It contacts the side of your drum to help protect it from being marred in handling. It is available as a bolt-on accessory.

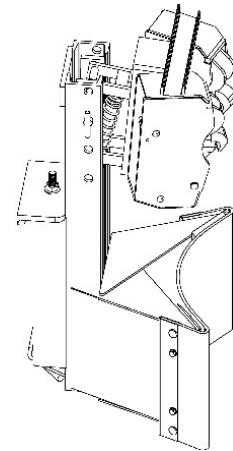

Important

1. Review the Material Safety Data Sheet(s) for the material(s) in the drum(s) and take all necessary precautions. Safety shoes, work gloves, hard hat and other personal protective devices are recommended.
2. Please read all instructions thoroughly before attempting to operate your new Morse drum handler.
3. The model 287-2H has a maximum capacity rating of 1500 Lb. (680 kg) per drum. Exceeding this rating or handling drums other than those mentioned above is unsafe and could result in equipment damage, excessive wear or awkward handling.
4. When loading, unloading, operating, or maintaining your MORSE drum handler, always use care and good judgment. Maintain secure footing and a firm hold. Keep hands and loose clothing away from all moving parts. Never allow anyone to be below any part of a raised drum handler or drum. Read operating instructions and review the pictures in the sales brochure before operation.
5. Because the Morse model 287-2H is a front-end attachment for a forklift, OSHA recommends that "... the truck (forklift) be marked to identify the attachment(s) and show the approximate weight of the truck and attachment combination at maximum elevation with load laterally centered." See center of gravity dimensions of model 287-2H for calculating lost load on your equipment.
6. Prior to initial use, inspect all moving parts. Inspect for proper operation. Perform necessary load test, inspections, operator training, etc.

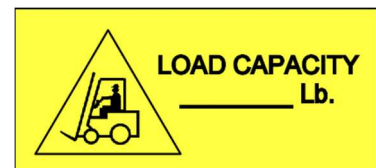

Operating Instructions

1. Mount one or two of model 287-2H onto center of ITA class 2 carriage or *MORSPEED*[™] Fork Reach Mount (model 288-0). If mounting two of model 287-2H onto your carriage, space them apart so the *MORSPEED*[™] jaws are approximately one drum diameter center to center. Secure to carriage by tightening 5/8-11 hex nut.
2. For 55-gallon steel drums, set *MORSPEED*[™] Heads in carriage mount so that cross-pin is in the top or second hole. For shorter drums use suitable lower holes. It is always best to keep Vee Backrest as close to the bottom of the drum as possible.
3. Set rake of mast so that when lifted, the *MORSPEED*[™] Carriage Mounts are vertical or inclined slightly forward. This setting should be maintained.
4. Approaching the drums for lifting: Drive truck with unit low to the floor. Steer to make the *MORSPEED*[™] head meet the drum straight-on at its center-line. The head should push into the side of the drum near the drum top. *MORSPEED*[™] jaws must arrive below the rim of the drum. Operator can gauge the proper height by aligning the top of the head(s) to be about flush with the top of the drum. If necessary, lower the carriage before contacting the drum to assure jaws will be below the rim before lifting.
5. As the *MORSPEED*[™] Heads are driven against the drums, the spring loaded parallel links will pivot downward to cushion against the drum. Spring pressure will tend to keep the head(s) forward, in contact with the drum during lifting to assure that the lower jaw catches the rim during the lift.
6. Raise carriage in one steady movement until drums are seen to be properly suspended. Avoid any tendency to interrupt the lift while the *MORSPEED*[™] Jaws operate to grab the drum. After very little practice, operations 5, 6, and 7 will be done easily in one flow of action.

TIP: It is not necessary to tilt the mast forward or back to effect gripping or releasing.

TIP: It is not necessary to have the jaws make first contact with the drum rim. Simply drive them in below the rim and raise. They will engage as the lower jaws catch under the rim as the *MORSPEED*[™] rises.

TIP: It is not necessary to tilt the mast backward as you might when handling pallets. If, after the drums are properly lifted, you want to tilt them back to clear other drums, this is permissible. Reset the mast to the original position (with *MORSPEED*[™] upright, drum will tilt forward slightly) before drums are put down and released.

TIP: If lifting two drums that are not spotted side by side, it may be necessary to lift one, carry it and put it down next to the other drum. Then both can be picked up together, side by side.

Operating Instructions Continued

7. Drive the truck to deliver the drums as necessary.



WARNING: Once drum is correctly picked-up, it should remain held safely by the *MORSPEED*[™] unless the truck is driven fast over a bad ridge or wide crack in the ground. The sudden movement could momentarily make drum weightless, thus allowing the jaws to open. Therefore, good truck discipline should be followed by keeping the load low when moving from place to place and by avoiding unreasonable surfaces and speeds.

8. To release drums, simply lower them until the *MORSPEED*[™] Jaws open automatically. Do not stop lowering as soon as drums touchdown, keep going down for a few more inches. Then you can back away.

TIP: USE OF VEE BACKREST TO POSITION DRUMS: Drums standing on the floor can be positioned for picking up by tilting the truck mast backward so the *MORSPEED*[™] Heads will clear the drums. The Vee Backrest can then be used to push the drums to locate them correctly. To lift drums, return mast to proper position as in Step 3 and Note in Step 7.

Possible Reasons for Failure to Pick Up Drum

- Carriage mount not lifting vertically (paragraph 3 in Operating Instructions).
- Truck not being squared up (paragraph 4 in Operating Instructions).
- Truck being allowed to creep backwards after contact with drums has been made.
- Truck driver tilting mast backwards.

Possible Reasons for Failure to Release Drum

- Procedure in paragraph 8 of Operating Instructions not being followed.
- Carriage mount not vertical. If mast is tilted backward, the drum may meet the floor leaning backward. As drum settles and tries to return to upright it may pull against inside of the upper jaw "hook" preventing the upper jaw from moving cleanly upward and away to release the drum.

Maintenance

Regular lubrication of moving parts is recommended. The *MORSPEED*[™] Head should be protected from the weather when not in use. Apply 90W oil generously to all moving joints and spring-anchor points approximately every 500 drum lifting cycles.

The Manufacturer cannot be held responsible for any consequences if spare parts other than genuine Morse parts supplied by them are used.

Center of Gravity Dimensions For Calculating Lost Load on Lifting Equipment

Model 287-2H Net Weight 171 Lb. (77.6 kg).

Option 2523-P Add to Model 5 Lb. (2.3 kg).

