

Contents

	Page
Receiving Procedures.	1
Warranty.	1
Safety Information.	1 - 2
Machine Description.	3 - 4
Operating Instructions.	5
Maintenance.	5

Operator's Manual
for Morse Vertical-Lift Drum Pourer
Model 520-114

Serial Number 225512 to 242093

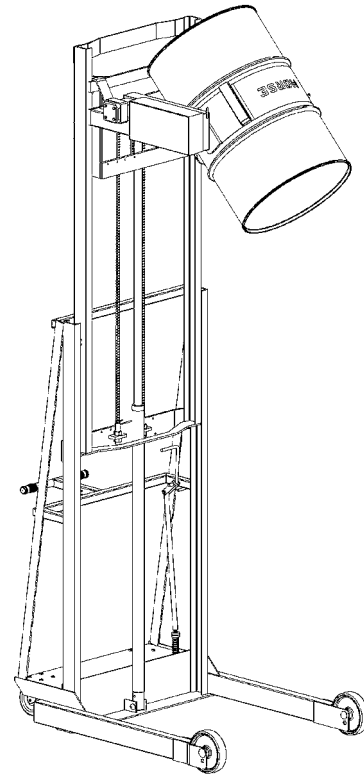

Receiving Procedures

Every Morse drum handler is inspected prior to shipping. However, damage may be incurred during transit.

- Check for visible damage. If you choose to accept damaged freight, always sign noting the damage on the **Bill of Lading**.
- Document the damage and have the truck driver sign. We recommend keeping a digital camera at your receiving dock for this purpose.
- Open packages expeditiously to check the condition of the goods. There is only a 24 hour window to notify the carrier of any concealed damage.
- Immediately **report all damage to the shipping company!** Then you may contact Morse for assistance with your freight claim.
- Morse Manufacturing will not be held responsible for any damaged freight that is not signed for as damaged.

Limited 2 Year Warranty

Morse drum handling equipment is guaranteed against defects in workmanship or materials for two years when used properly within its rated capacity. Warranty does not cover wear from normal use or damage from accident or abuse. Motors and other purchased parts carry the warranties of their manufacturers.

For warranty claims, contact your Morse Dealer to obtain a return authorization number, and for return freight advice. Return freight must be prepaid.

In all instances, liability is limited to the purchase price paid or to repairing or replacing the product. Customer assumes liability for any modifications, unauthorized repairs or parts substitution.

Safety Information

While Morse Manufacturing Co. drum handling equipment is engineered for safety and efficiency, a high degree of responsibility must be placed upon the machine operator to follow safe practices, based primarily on common sense, upon which true safety depends.

Failure to follow the safety precautions in this manual can result in personal injury or property damage. Observe the same precautions as with similar machinery where carelessness in operating or maintenance is hazardous to personnel. Carefully read the safety precautions below and throughout this manual.

Review the Material Safety Data Sheet(s) for the material(s) in the drum(s) and take all necessary precautions. Safety shoes, work gloves, hard hat and other personal protective devices are recommended.

Prior to initial use, inspect all moving parts and test rotation of drum holder. Perform necessary load test, inspections, operator training, etc.

Operator's Manual for Morse Vertical-Lift Drum Pourer Model 520-114
Serial Number 225512 to 242093

Safety Information (continued)



DANGER - Indicates a situation which, if not avoided, *will* result in serious injury or death. This signal word is limited to the most extreme situations.



WARNING - Indicates a situation which, if not avoided, *could* result in serious injury or death.



CAUTION - Indicates a situation which, if not avoided, can result in damage to the machine.



CAUTION - Do NOT transport with drum raised.

Always lower the drum holder to lowest position before transporting.



DANGER - Stay well clear of power lines.

Never approach a power line. Current in a high voltage line may arc some distance from the wire to the steel framed, grounded machine.



WARNING - The Vertical-Lift Drum Pourer is designed to handle one drum of the types listed at the top of page 3 - Machine Description. DO NOT attempt to handle any other type of drum or object. DO NOT exceed the weight capacity of 800 Lb.



WARNING - Level floors only.

For operation only on clean, level floors of suitable bearing capacity. Do not use on sloped surfaces, ramps, irregular or debris strewn floors.



WARNING - Do NOT modify the unit.

Under no circumstances should any modifications be made to the Morse machinery without factory authorization. Any modifications may void the warranty. This machine was designed to perform a specific job and alterations may result in injury to operator or machine.



WARNING - No loose fitting clothing.

Wear close-fitting clothing and safety equipment appropriate to the job. Loose fitting clothing may become caught on the machinery and cause severe personal injury.



WARNING - Hydraulic fluid under pressure can be hazardous.

Escaping hydraulic fluid under pressure can penetrate the skin, causing serious injury. Avoid the hazard by relieving pressure before disconnecting hydraulic lines. Keep hands and body away from pinholes and nozzles, which eject fluid under high pressure. Use a piece of cardboard to search for leaks. If an accident occurs, see a doctor immediately and inform them of the nature of the accident.



CAUTION - Wear safety shoes.

Wear safety shoes with non-slip soles and hard toe protection.

Operator's Manual for Morse Vertical-Lift Drum Pourer Model 520-114
Serial Number 225512 to 242093

Machine Description

The Model 520-114 Vertical-Lift Drum Pourer will pour a drum at up to 106" high, measured from the floor to the lowest point of a horizontal drum. It is designed to lift, transport, and dispense a ribbed 55-gallon steel drum 22.5" in diameter, as well as a fiber drum between 22" and 23.5" in diameter. The maximum full-drum capacity is 800 Lb. The capacity is derated to 500 Lb. for a half-full drum. The half-full rating is based on the tilt mechanism's capacity for handling an unbalanced bottom-heavy drum.



Options

- A smaller diameter drum can be handled with the correct size 55/30 Series Diameter Adaptor installed (see Diameter Adaptor literature).
- A 55-gallon plastic drum can be handled with either the Adjustable HDPS Bracket (Part # 1465-P) or the Top Rim Clamp (Part # 3540-P). Use the Top Rim Clamp with a plastic drum that has a suitable top rim (see figure 2.1). Use the Adjustable Bracket for a drum with or without a top rim (see figure 2.2).

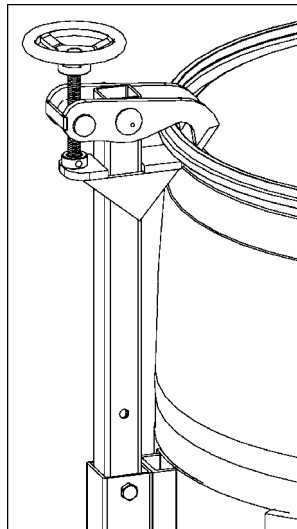

Figure 2.1
Plastic drum being lifted with part number 3540-P Rim Clamp Assembly installed.

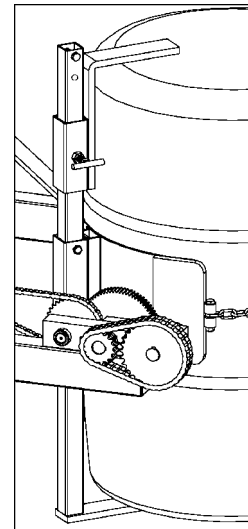

Figure 2.2
Plastic drum being lifted with part number 1465-P Bracket Assembly installed.

Operator's Manual for Morse Vertical-Lift Drum Pourer Model 520-114
Serial Number 225512 to 242093

Controls

The Morse Vertical-Lift Drum Pourer is manually propelled and steered. The drum lift and tilt controls are powered by a vane type air motor. The air motor is controlled by a momentary air valve. Attach air supply to air valve.

There are two functions for the operator to control (Figure 3.1):

1. "LIFT" and lower function for vertical positioning of the drum
2. "TILT" function to control the degree of rotation of the drum

1. LIFT and Lower Function

To raise the drum

- a. Hold the air valve handle in the on position and raise "LIFT" handle.
- b. Release the two valve handles when desired drum height is reached.

To lower the drum

- a. With the motor off, push in the "LOWER" handle.

2. TILT Function

To tilt the drum forward for pouring

- a. Turn on the air motor by holding the air valve handle in the on position.
- b. With the motor on, raise the "TILT" handle.

To return the drum to vertical position

- a. Turn on the air motor by holding the air valve handle in the on position.
- b. Push the "TILT" handle down.

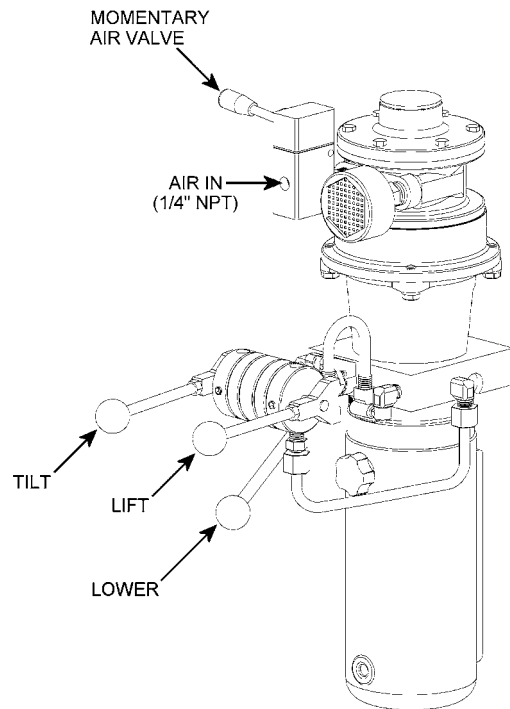

Figure 3.1



WARNING - Watch out for pinch points

Stay clear of moving parts. Operator should remain behind the push handle during the lift operation.

Floor Lock

The floor lock handle is located on the left side of the push handle. Pulling the floor lock handle toward the operator until it locks in the down position activates the floor lock. When the floor lock is activated it prevents unwanted free wheeling of the unit. Floor conditions determine the effectiveness of the floor lock. The operator should verify its holding action before depending on it to hold.

Drum Holder Assembly

The drum holder assembly (or "saddle assembly") is the component on the Vertical-Lift Drum Pourer that is intended to hold the drum. The drum holder assembly moves vertically along the mast, and is designed to secure a drum around its middle using a strap and ratchet tightening system. The drum holder accepts accessories for handling a 55-gallon plastic drum or a smaller diameter drum.

Operator's Manual for Morse Vertical-Lift Drum Pourer Model 520-114
Serial Number 225512 to 242093

Operating Instructions

1. Push the Vertical-Lift Drum Pourer to the drum.
2. Using the "LIFT" control as described in "Machine Description - Controls" (page 4), position the drum holder assembly with the back band at the middle of the drum. With the ratchet plate swung open and the strap hanging from the chain hook, push the unit until the back band rests firmly against the drum. Some adjustment to the tilt angle of the saddle may be necessary to ensure band fits flush on the drum. Engage the floor lock.

3. **Attaching the drum:** Drape the strap across the front of the drum and engage a chain link into the slot in the ratchet (Figure 3.2). Turn the ratchet clockwise to tighten strap. If ratchet turns until the pawl is beyond the last ratchet tooth, turn the ratchet back and slide the next link into the ratchet slot and try tightening again. The strap must be held tightly against the drum with the pawl engaged securely in the ratchet teeth.

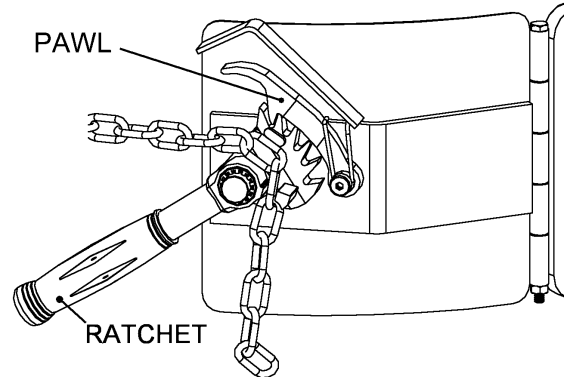
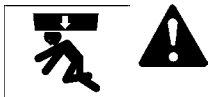

Figure 3.2

4. Operate the lift function to lift drum clear of floor. Disengage floor lock. Roll to dispensing location. NOTE: Do not allow the drum to impact on floor, pouring station, etc. or a spill or damage could occur.



CAUTION – Do NOT transport with drum raised.
ALWAYS LOWER THE DRUM HOLDER TO LOWEST POSITION BEFORE TRANSPORTING.
The unit can become unstable when transporting with a raised load.

5. Lift drum to desired pouring height. Operate the tilt control as described in "Machine Description - Controls" (page 4) to adjust the drum attitude. The floor lock should be engaged while dispensing / draining.
6. When dispensing is complete, tilt drum back to upright position. Disengage the floor lock and lower the drum to transporting height; about 6" off the floor.



WARNING - Stay clear of raised drum
NEVER allow anyone to be below any part of a raised drum handler or drum. Remain behind the push handle while handling a drum.



WARNING – Do NOT disengage the strap when drum is off the ground.
When the drum is in the upright position, lower the drum to the floor before releasing the strap.

7. Push the unit to the drum storage area and lower to the floor in an upright position. Release the strap from the ratchet by applying pressure to the ratchet handle in a clockwise direction with one hand and opening the pawl to free the ratchet with the other hand. Remove the chain link from the ratchet.

Maintenance

1. Periodic inspection for the general condition of structural and mechanical components is imperative for safe and efficient operation.
2. Periodically inspect all moving parts, framework, drum holder and contact areas for signs of wear, fatigue, or loosening. Tighten, adjust, or replace parts as necessary to prevent failure and maintain proper function.
3. Inspect the hydraulic system for oil drips, hose damage, or other signs of wear. Inspect the level of the hydraulic fluid. Replace any parts that show signs of wear.
4. Grease wheel bearings periodically. Oil or grease all moving parts, including: the hinge pin, the gears and sprockets in the tilt drive, and the ratchet and pawl.
5. Worn or damaged parts must be properly replaced with the correct, genuine Morse parts.