

CONTENTS

- Receiving Procedures
- Warranty
- Safety Information
- Machine Description
- Accessories
- Assembly Instructions
- Operating Instructions
- Maintenance



Receiving Procedures

Every Morse drum handler is inspected prior to shipping. However, damage may be incurred during transit.

- Check for visible damage. If you choose to accept damaged freight, always sign noting the damage on the **BILL OF LADING**.
- Document the damage and have the truck driver sign. We recommend keeping a digital camera at your receiving dock for this purpose.
- Open packages expeditiously to check the condition of the goods. There is only a 24 hour window to notify the carrier of any concealed damage.
- **IMMEDIATELY REPORT ALL DAMAGE TO THE SHIPPING COMPANY!** Then you may contact Morse for assistance with your freight claim.
- Morse Manufacturing will not be held responsible for any damaged freight that is not signed for as damaged.

Limited 2 Year Warranty

Morse drum handling equipment is guaranteed against defects in workmanship or materials for **TWO YEARS** when used properly within its rated capacity. Warranty does not cover wear from normal use or damage from accident or abuse. Motors and other purchased parts carry the warranties of their manufacturers.

For warranty claims, contact your Morse Dealer to obtain a return authorization number, and for return freight advice. Return freight must be prepaid.

In all instances, liability is limited to the purchase price paid or to repairing or replacing the product. Customer assumes liability for any modifications, unauthorized repairs or parts substitution.

Safety Information

While Morse Manufacturing Co. drum handling equipment is engineered for safety and efficiency, a high degree of responsibility must be placed upon the machine operator to follow safe practices, based primarily on common sense, upon which true safety depends.

Failure to follow the safety precautions in this manual can result in personal injury or property damage. Observe the same precautions as with similar machinery where carelessness in operating or maintenance is hazardous to personnel. Carefully read the safety precautions below and throughout this manual.

Review the Material Safety Data Sheet(s) for the material(s) in the drum(s) and take all necessary precautions. Safety shoes, work gloves, hard hat and other personal protective devices are recommended.

Prior to initial use, inspect all moving parts and test rotation of chain wheel and drum holder assembly. Inspect drum holder assembly for proper operation. Perform necessary load test, inspections, operator training, etc.















DANGER - Indicates a situation which, if not avoided, will result in serious injury or death. This signal word is limited to the most extreme situations.



WARNING - Indicates a situation which, if not avoided, could result in serious injury or death.



CAUTION - Indicates a situation which, if not avoided, can result in damage to the machine.

	WARNING - Kontrol-Karriers are designed to handle one drum of the types listed in Machine Description. DO NOT attempt to handle any other type of drum or object.
	WARNING - DO NOT exceed the weight capacity of 2500 Lb. (1134 kg).
	WARNING - DO NOT operate damaged or malfunctioning unit, or a unit with missing parts.
	WARNING - DO NOT lift people or suspend loads over people. Stay clear of suspended loads.
	WARNING - DO NOT lift loads higher than necessary.
	WARNING - DO NOT leave suspended loads unattended.
	WARNING - DO NOT remove or obscure warning labels.
	WARNING - DO NOT operate without first having read and understood operating manual.
	WARNING - Do Not Modify the Unit. Under no circumstances should any modifications be made to the Morse machinery without factory authorization. Any modifications may void the warranty. This machine was designed to perform a specific job and alterations may result in injury to operator or machine.
	CAUTION - Wear safety shoes with non-slip soles and hard toe protection.
	CAUTION - DO NOT allow drum to impact on floor, ground, or dumping station, etc.
	WARNING - This product can expose you to chemicals including barium sulfate, cobalt, titanium dioxide, and 2-methylimidazole, which are known to the State of California to cause cancer, and bisphenol-A, which is known to the State of California to cause birth defects or other reproductive harm. For more information go to www.P65Warnings.ca.gov

Machine Description

Model 185XGR Super-Duty Kontrol-Karrier is designed to lift, transport, and dispense a ribbed 55-gallon (210 liter) steel drum 22.5" (57.2 cm) in diameter.

The maximum full-drum capacity is 2500 Lb. (1134 kg). Capacity is derated to 1250 Lb. (567 kg) for a half-full drum. Half-full rating is based on the tilt mechanism's capacity for handling an unbalanced bottom-heavy drum.



Important

1. Please read all instructions thoroughly before attempting to operate your new Morse drum handler.
2. Prior to initial use, inspect all moving parts and test rotation of chain wheel and saddle assembly. Inspect saddle assembly for proper operation. Perform necessary load test, inspections, operator training, etc.
3. When loading, unloading, operating, or maintaining your MORSE drum handler, always use care and good judgment. Maintain secure footing and a firm hold. Keep hands and loose clothing away from all moving parts. Never allow anyone to be below any part of a raised drum handler or drum. Read operating instructions and review the pictures in the sales brochure before operation.
4. The Kontrol-Karriers is a "Group 1 structural and mechanical" below-the-hook lifting device which are covered by the American National Standard ASME B30.20. The user should comply with all aspects of this standard.
5. Model 185XGR has a maximum capacity rating of 2500 Lb. (1134 kg) full drum and 1250 Lb. (567 kg) half-full drum and is designed to lift, move and pour a 55-gallon (208 liter) steel drum. DO NOT exceed these ratings. Exceeding these ratings or handling drums other than those mentioned above is unsafe and could result in equipment damage, excessive wear or awkward handling.
6. Review the Material Safety Data Sheet(s) for the material(s) in the drum(s) and take all necessary precautions. Safety shoes, work gloves, hard hat and other personal protective devices are recommended.

Assembly Instructions

1. Remove the following items from small cardboard box packaged with 185XGR: chain wheel, chain guide with pull chain, roll pin.
2. Slide chain wheel assembly onto shaft with the chain guide facing outward.
3. Insert roll pin to retain chain wheel on the speed reducer input shaft.
4. Prior to initial use, inspect all moving parts and test rotation of chain wheel and saddle assembly. Perform necessary load test, inspections, operator training, etc. as prescribed in the ANSI/ASME B30.20 standard.

Operating Instructions

1. With Kontrol-Karrier standing on floor, lower hoist and engage hoist hook into lifting eye.
2. Raise hoist to lift Kontrol-Karrier clear of floor and move it to drum.
3. Position Kontrol-Karrier at a height which aligns drum holder (saddle) band with center of drum.
4. Open toggle clamp by activating release lever and swing both hinge bands to open position. Push the Kontrol-Karrier against drum to surround drum with saddle band.
5. Close two hinged bands around drum and latch toggle clamp to secure drum.
6. Raise hoist and position drum at pouring station.
7. Pour drum by pulling on pull chain and rotating drum to suitable pouring angle.
8. After pouring is completed, rotate drum back to vertical position and lower hoist to return drum to floor.
9. Remove drum by activating release lever and opening toggle clamp. Swing both hinged bands open. Push Kontrol-Karrier away from drum.



CAUTION: DO NOT allow drum to impact on floor, ground, or dumping station, etc.



CAUTION: DO NOT exceed weight capacity of 2500 Lb. (1134 kg) for FULL drum, 1250 Lb. (567 kg) for HALF-FULL drum.



WARNING: Watch out for pinch points - Stay clear of moving parts.

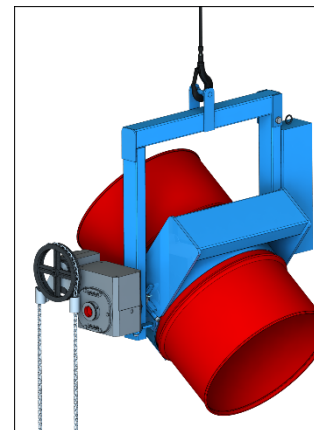
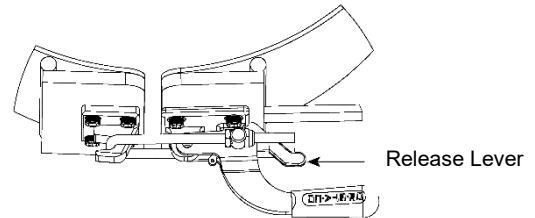
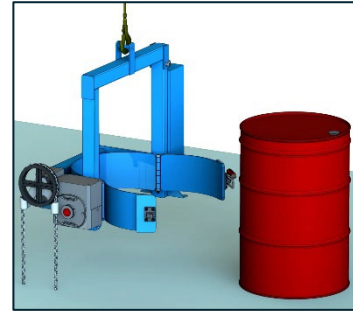

Maintenance

1. The speed reducer has been filled with grease and tested prior to shipment. No maintenance is required.
2. Periodically inspect all moving parts, framework, and contact areas for signs of wear, fatigue, or loosening. Perform all inspections, load tests, and maintenance according to the ANSI/ASME B30.20 standard.
3. Worn or damaged parts must be properly replaced with the correct, genuine Morse parts.
4. Ensure all labels are in place. Product labels should be inspected periodically and cleaned as necessary to maintain good legibility. Please contact Morse Mfg. Co. for replacement labels.