

CONTENTS

- **Receiving Procedures**
- **Warranty**
- **Safety Information**
- **Machine Description**
- **Accessories**
- **Operating Instructions**
- **Maintenance**



Receiving Procedures

Every Morse drum handler is inspected prior to shipping. However, damage may be incurred during transit.

- Check for visible damage. If you choose to accept damaged freight, always sign noting the damage on the **BILL OF LADING**.
- Document the damage and have the truck driver sign. We recommend keeping a digital camera at your receiving dock for this purpose.
- Open packages expeditiously to check the condition of the goods. There is only a 24 hour window to notify the carrier of any concealed damage.
- **IMMEDIATELY REPORT ALL DAMAGE TO THE SHIPPING COMPANY!** Then you may contact Morse for assistance with your freight claim.
- Morse Manufacturing will not be held responsible for any damaged freight that is not signed for as damaged.

Delivery to non-business addresses without a loading dock result in additional freight charges. Residential delivery fees, inside delivery fees, re-delivery charges, and lift gate services will be added by the truck line, and are non-negotiable.

Limited 2 Year Warranty

Morse drum handling equipment is guaranteed against defects in workmanship or materials for **TWO YEARS** when used properly within

its rated capacity. Warranty does not cover wear from normal use or damage from accident or abuse. Motors and other purchased parts carry the warranties of their manufacturers.

For warranty claims, contact your Morse Dealer to obtain a return authorization number, and for return freight advice. Return freight must be prepaid.

In all instances, liability is limited to the purchase price paid or to repairing or replacing the product. Customer assumes liability for any modifications, unauthorized repairs or parts substitution.

Safety Information

While Morse Manufacturing Co. drum handling equipment is engineered for safety and efficiency, a high degree of responsibility must be placed upon the machine operator to follow safe practices, based primarily on common sense, upon which true safety depends.

Failure to follow the safety precautions in this manual can result in personal injury or property damage. Observe the same precautions as with similar machinery where carelessness in operating or maintenance is hazardous to personnel. Carefully read the safety precautions below and throughout this manual.













DANGER - Indicates a situation which, if not avoided, will result in serious injury or death. This signal word is limited to the most extreme situations.



WARNING - Indicates a situation which, if not avoided, could result in serious injury or death.



CAUTION - Indicates a situation which, if not avoided, can result in damage to the machine.

 	<p>CAUTION – Do Not Transport with Drum Raised. Always lower the drum holder to lowest position before transporting.</p>
	<p>WARNING - The Mobile-Karrier / Palletizer is designed to handle one drum of the types listed in Machine Description. DO NOT attempt to handle any other type of drum or object. DO NOT exceed the weight capacity of 600 Lb. (272 kg).</p>
	<p>WARNING - Level Floors Only For operation only on clean, level floors of suitable bearing capacity. Do not use on sloped surfaces, ramps, irregular or debris strewn floors.</p>
	<p>WARNING - Do Not Modify the Unit. Under no circumstances should any modifications be made to the Morse machinery without factory authorization. Any modifications may void the warranty. This machine was designed to perform a specific job and alterations may result in injury to operator or machine.</p>
	<p>WARNING - No Loose Fitting Clothing. Wear close-fitting clothing and safety equipment appropriate to the job. Loose fitting clothing may become caught on the machinery and cause severe personal injury.</p>
	<p>WARNING - Hydraulic Fluid Under Pressure Can Be Hazardous Escaping hydraulic fluid under pressure can penetrate the skin, causing serious injury. Avoid the hazard by relieving pressure before disconnecting hydraulic lines. Keep hands and body away from pinholes and nozzles, which eject fluid under high pressure. Use a piece of cardboard to search for leaks. If an accident occurs, see a doctor immediately and inform them of the nature of the accident.</p>
	<p>CAUTION - Wear safety shoes with non-slip soles and hard toe protection.</p>
	<p>CAUTION - DO NOT allow drum to impact on floor, ground, or dumping station, etc.</p>
	<p>WARNING - This product can expose you to chemicals including barium sulfate, cobalt, titanium dioxide, and 2-methylimidazole, which are known to the State of California to cause cancer, and bisphenol-A, which is known to the State of California to cause birth defects or other reproductive harm. For more information go to www.P65Warnings.ca.gov</p>

Machine Description

The Mobile-Karrier / Palletizer is designed to lift, transport, and dispense a ribbed 55-gallon (210 liter) steel drum with 22.5" (57.2 cm) diameter. The maximum capacity is 600 Lb. (272 kg).

MORSE
Mfg. Co., Inc.
E. Syracuse, NY
The Specialist
in Drum
Handling
Equipment

600 Lb. Max. Capacity
(272 kg)

Made in U.S.A.

Accessories

55/30 Series Diameter Adapters for drum with diameter smaller than 22" (56 cm). To handle a smaller drum, insert the correct size Diameter Adapter into the standard drum holder. See Diameter Adapter info at: <https://morsedrum.com/products/diameter-adapters>

All Diameter Adapters for drum with 17.5" (44.5 cm) diameter or smaller have integrated brackets to prevent drum slipping length-ways.

NOTE: To prevent 30-gallon (114 Liter) PLASTIC drum from slipping install ONE of the following

1. Diameter Adapter 55/30-19B which has integrated brackets
2. Diameter 55/30-19 **AND** either Bracket 4556-P or Top Rim Clamp 4560B-P

IMPORTANT: To prevent a PLASTIC 30 to 55 gallon (114 to 210 Liter) size drum from slipping, you **MUST** install either Top Rim Clamp Kit or Bracket Assembly Kit.

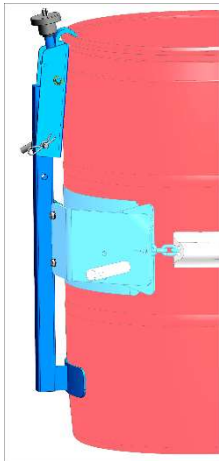
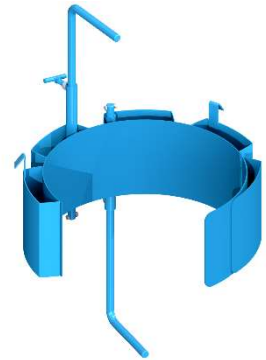

Top Rim Clamp Kit 4560B-P

Handle RIMMED plastic drum.

Install the Top Rim Clamp Kit to handle a RIMMED plastic, steel or fiber drum with suitable top rim.

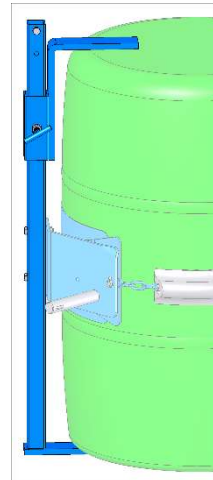

Bracket Assembly Kit 4556-P

Required to handle RIMLESS plastic drum. Also recommended for fiber drum.

Bracket adjusts for 31" to 39" (79 to 99 cm) tall drum.

You can also handle a rimmed drum with Bracket installed.



Kit 3900-P
MORStop™ Tilt-Brake

Automatically holds drum tilt angle until you move it.



Kit 2690-P
Hand Wheel

16" (40.6 cm) diameter
 Hand Wheel with speed knob.
 Replaces standard pull chain to turn drum.

Controls

The Morse Mobile-Karrier / Palletizer is manually propelled and steered. The drum lift function is powered by a 12V DC motor.

There are two functions for the operator to control:

1. "LIFT" and lower function for vertical positioning of the drum
2. "TILT" function to control the degree of rotation of the drum

LIFT and Lower Function

To raise the drum

- Push and hold the valve handle in against the start switch.
- Release the handle when the drum is at the desired height.
- To lower the drum: Pull and hold the valve handle out away from the start switch.

TILT Function

To tilt the drum

- Turn the hand crank to turn the drum.
- Before releasing your grip on the hand crank, pull out the crank stop pin to block the hand crank from spinning freely.
- If the drum handler is equipped with the MORStop™ Tilt-Brake, there is no need to use the stop pin. Braking is immediate and self-actuating, without additional steps by the operator.

Note: To add the MORStop™ Tilt-Brake to an existing drum handler, order part # 3900-P for a field installation kit.

START SWITCH

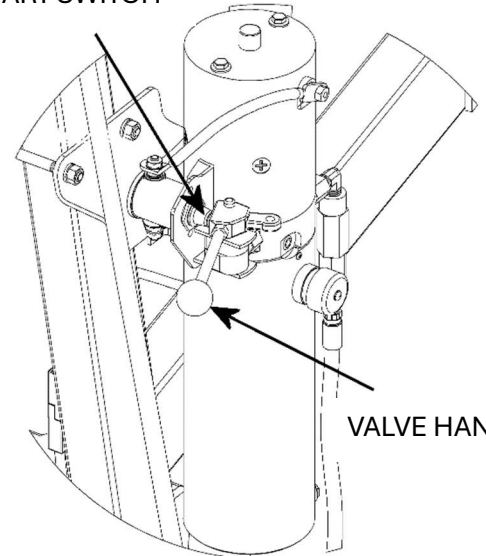

VALVE HANDLE

Operating Instructions

1. Roll drum lifter to drum. Steer unit so drum holder meets middle of drum. Operate hydraulics as necessary. Roll the unit forward and push drum holder so it slips around the drum.

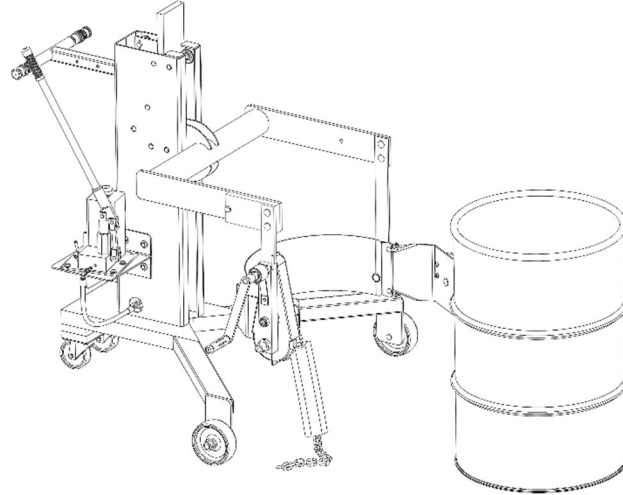

WARNING - Keep hands and other objects away from top opening of lifting frame.

2. To secure drum: drape cinch chain across face of drum and engage a link into notch in hub of ratchet. Pull up on ratchet handle to tighten chain. If ratchet turns to extent that pawl is beyond last ratchet tooth and chain is not tight, back up and try putting next link in notch. Chain should tighten as ratchet turns and be held tight by teeth of ratchet & pawl. Firm hand pressure on ratchet handle should tension chain sufficiently to secure drum. **DO NOT** use mechanical aids such as a pipe to extend ratchet handle for extra leverage.

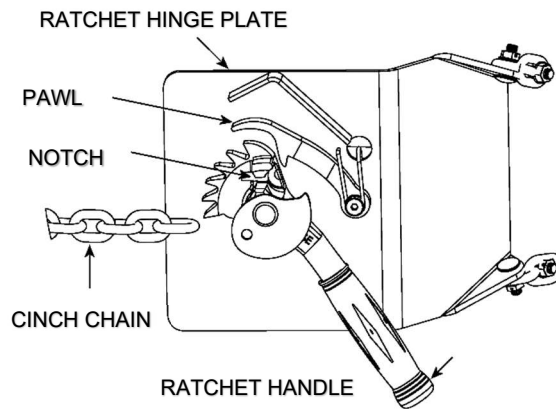

3. Operate lift function to raise drum off the floor, push drum lifter to deliver drum. Avoid unreasonably rough or non-level surfaces. Move at moderate speed. Carry drum only high enough to avoid contact with the floor or obstacles. Push loaded unit when possible for transporting. Pulling unit should be limited to maneuvering at short distance.
4. Lift drum to desired pouring height. Operate the tilt control as described in "Machine Description - Controls" to adjust the drum attitude. When dispensing is complete, tilt drum back to upright position. Lower drum to transporting height.
5. Before unloading drum, return drum to upright. Lower drum at a controlled rate.
6. To remove drum: pull ratchet handle clockwise to relieve pressure on ratchet teeth. Lift pawl handle to release teeth engagement and rotate ratchet counterclockwise to loosen chain and allow its removal from notch. Pull unit away and park on level floor, out of traffic lanes when not in use.
7. Adjustment for Shorter Drums: The drum holder assembly is factory set in upper position for handling typical 55-gallon (210 liter) drum. For handling shorter drums such as typical 30-gallon (114 liter) drums, relocate drum holder assembly downward as follows: Detach by removing nuts that hold it to lifting assembly. Reattach at alternate location 6" (15.24 cm) lower.

Maintenance

- Periodic inspection for the general condition of structural and mechanical components is imperative for safe and efficient operation.
- Periodically inspect all moving parts, framework, and contact areas for signs of wear, fatigue, or loosening. Tighten, adjust, or replace parts as necessary to prevent failure and maintain proper function.
- Inspect the hydraulic system for oil drips, hose damage, or other signs of wear. Inspect the level and condition of the hydraulic fluid. Replace any parts that show signs of wear.
- Grease wheel bearings periodically. Oil or grease all moving parts including: Tilt gears, sprockets, chain, the hinge pin, and the ratchet and pawl.
- Worn or damaged parts must be properly replaced with the correct, genuine Morse parts.
- Hydraulic pump is shipped filled with Noco Premium plus automatic transmission fluid d/m. Safety data sheet (SDS / MSDS) is available online. Change oil yearly, sooner depending on dirty conditions or outdoor use. Replace oil with Mobil dte 24 or equivalent for indoor use (Mobil dte 13 for outdoor use).