

#### Parts Diagram for Part # 101Z-P Drum Holder (Saddle) Assembly (Drum Holder)

##### Used on

- 82A Series with Serial Number 0509 to 1014 (MMYY)
- Model 80i with Serial Number 0509 to 1014 (MMYY)
- Model 85i with Serial Number 0509 to 1014 (MMYY)



#### IMPORTANT NOTE

4-Digit serial numbers are simply the month & year of manufacture

Example: 0802 is August 2002

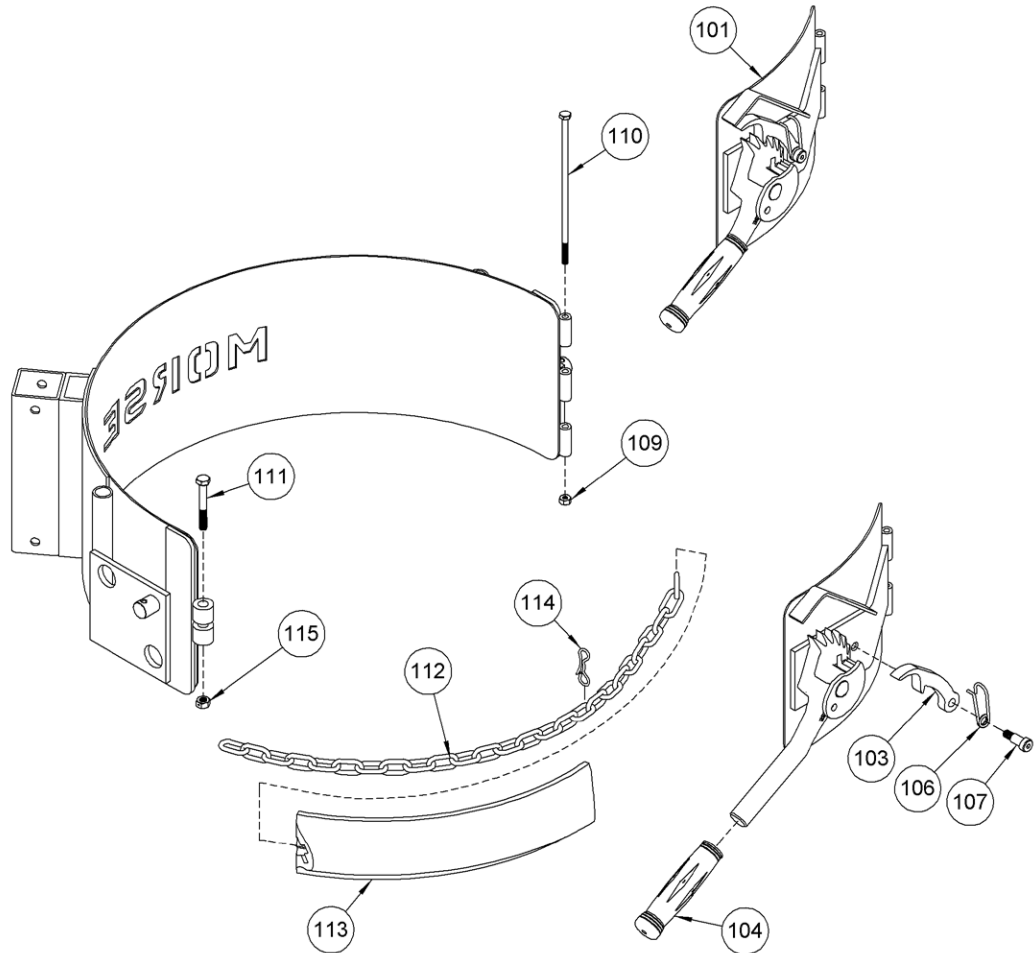

ITEM	QTY.	PART #	DESCRIPTION
101*	1	727A-P	RATCHET PLATE CPT W/ TAB 1/4"
103	1	168-P	PAWL, WITH DRILLED HOLE
104	1	136-P	GRIP, HANDLE 7/8" X 4-3/4"
106	1	169-P	SPRING, PAWL
107	1	170-P	SCREW, 3/8 DIA X 5/8 SHOULDER
109*	1	1297-P	NUT, 1/4-20 REV HEX LOCK
110*	1	1296-P	HHCS, 1/4-20 X 7-1/2 GR5
111*	1	4079-P	HHCS, M8 X 60 MM CL8.8, 8MM
112*	1	5017-P	CHAIN, CINCH, 9/32, 38 LINK
113*	1	4414-P	COVER, CINCH CHAIN, FLEX PVC
114	1	4710-P	PIN, BOW TIE COTTER, MOR
115*	1	4081-P	NUT, M8 ESNA, 8MM

\* Recommended spare parts