

## CONTENTS

	Page
Receiving Procedures. . . . .	1
Warranty. . . . .	1
Safety Information. . . . .	1 - 2
Machine Description. . . . .	3
Operating Instructions. . . . .	4
Maintenance. . . . .	4
Parts Lists and Diagrams. . . . .	5 - 7

# Operator's Manual for Morse Kontrol-Karrier with 3-Piece Drum Holder, Spark Resistant Parts Air Power Tilt

**Model 195GM-A**  
with Serial Number 289926 to 291419

### Receiving Procedures

Every Morse drum handler is inspected prior to shipping. However, damage may be incurred during transit.

- Check for visible damage. If you choose to accept damaged freight, always sign noting the damage on the **Bill of Lading**.
- Document the damage and have the truck driver sign. We recommend keeping a digital camera at your receiving dock for this purpose.
- Open packages expeditiously to check the condition of the goods. There is only a 24 hour window to notify the carrier of any concealed damage.
- Immediately **report all damage to the shipping company!** Then you may contact Morse for assistance with your freight claim.
- Morse Manufacturing will not be held responsible for any damaged freight that is not signed for as damaged.

### Limited 2 Year Warranty

Morse drum handling equipment is guaranteed against defects in workmanship or materials for two years when used properly within its rated capacity. Warranty does not cover wear from normal use or damage from accident or abuse. Motors and other purchased parts carry the warranties of their manufacturers.

For warranty claims, contact your Morse Dealer to obtain a return authorization number, and for return freight advice. Return freight must be prepaid.

In all instances, liability is limited to the purchase price paid or to repairing or replacing the product. Customer assumes liability for any modifications, unauthorized repairs or parts substitution.

### Safety Information

While Morse Manufacturing Co. drum handling equipment is engineered for safety and efficiency, a high degree of responsibility must be placed upon the machine operator to follow safe practices, based primarily on common sense, upon which true safety depends.



Failure to follow the safety precautions in this manual can result in personal injury or property damage. Observe the same precautions as with similar machinery where carelessness in operating or maintenance is hazardous to personnel. Carefully read the safety precautions below and throughout this manual.











Review the Material Safety Data Sheet(s) for the material(s) in the drum(s) and take all necessary precautions. Safety shoes, work gloves, hard hat and other personal protective devices are recommended.

Prior to initial use, inspect all moving parts and test rotation of saddle assembly. Inspect saddle assembly for proper operation. Perform necessary load test, inspections, operator training, etc.

**Operator's Manual for Morse Models 195GM-A**  
**Serial Number 289926 to 291419**

**Safety Information** (continued)

	<b>DANGER</b> - Indicates a situation which, if not avoided, will result in serious injury or death. This signal word is limited to the most extreme situations.
	<b>WARNING</b> - Indicates a situation which, if not avoided, could result in serious injury or death.
	<b>CAUTION</b> - Indicates a situation which, if not avoided, can result in damage to the machine.

-  **WARNING** - Kontrol-Karriers are designed to handle one drum of the types listed at the top of page 3. Machine Description. DO NOT attempt to handle any other type of drum or object.
-  **WARNING** - DO NOT exceed the weight capacity.
-  **WARNING** - DO NOT operate damaged or malfunctioning unit, or a unit with missing parts.
-  **WARNING** - DO NOT lift people or suspend loads over people. Stay clear of suspended loads.
-  **WARNING** - DO NOT lift loads higher than necessary.
-  **WARNING** - DO NOT leave suspended loads unattended.
-  **WARNING** - DO NOT remove or obscure warning labels.
-  **WARNING** - DO NOT operate without first having read and understood operating manual.
-  **WARNING** - DO NOT make alterations or modify the unit. Under no circumstances should any modifications be made to the Morse machinery without factory authorization. Any modifications may void the warranty. This machine was designed to perform a specific job and alterations may result in injury to operator or machine.
-  **WARNING** - Wear safety shoes with non-slip soles and hard toe protection.
-  **CAUTION:** DO NOT allow drum to impact on floor, ground, etc.

**Operator's Manual for Morse Model 195GM-A**  
**Serial Number 289926 to 291419**

**Machine Description**

The Power Tilt Kontrol-Karrier is designed to lift, transport, and dispense a ribbed 55-gallon (208 liter) steel drum 22.5" (57.2 cm) in diameter.

The maximum full-drum capacity is 1500 Lb. (680 kg). The capacity is derated to 800 Lb. (363 kg) for a half-full drum. The half-full rating is based on the tilt mechanism's capacity for handling an unbalanced bottom-heavy drum.



**Important**

1. Please read all instructions thoroughly before attempting to operate your new Morse drum handler.
2. When loading, unloading, operating, or maintaining your MORSE drum handler, always use care and good judgment. Maintain secure footing and a firm hold. Keep hands and loose clothing away from all moving parts. Never allow anyone to be below any part of a raised drum handler or drum. Read operating instructions and review the pictures in the sales brochure before operation.
3. The 195 Series are a "Group 1 structural and mechanical" below-the-hook lifting device which are covered by the American National Standard ASME B30.20. The user should comply with all aspects of this standard.

**Operator's Manual for Morse Models 195GM-A  
Serial Number 289926 to 291419**

**Assembly Instructions**

1. Remove the metal screw-plug on top of the speed reducer.
2. Look into the hole to verify oil is in the speed reducer.
3. Install the plastic vent-plug in place of the metal screw-plug to allow internal pressure to equalize with atmospheric pressure.
4. Air motor requires 20 PSI at 22 SCFM. Operating the air motor at higher pressures will reduce the life of the air motor and power transmission components.
5. Prior to initial use, inspect all moving parts and test rotation of saddle assembly. Inspect saddle assembly (drum holder) for proper operation. Perform necessary load test, inspections, operator training, etc. as prescribed in the ANSI/ASME B30.20 standard.

**Operating Instructions**

1. With Kontrol-Karrier standing on the floor, lower hoist and engage hoist hook into the lifting eye.
2. Raise hoist to lift Kontrol-Karrier clear of floor and move it to the drum.
3. Position Kontrol-Karrier at a height which aligns the saddle band with the center of the drum.
4. Open the toggle clamp by activating the release lever (item 106) and swing both hinge bands to the open position. Push Kontrol-Karrier against the drum to surround the drum with the saddle band.
5. Close the two hinge bands around the drum and latch the toggle clamp to secure the drum.
6. Raise hoist and position the drum at the pouring station.
7. Pour the drum by pulling lever clockwise on the control valve (item 3).
8. After pouring is completed, rotate the drum back to vertical position and lower hoist to return drum to floor.
9. Remove the drum by activating the release lever and opening the toggle clamp. Swing both hinge bands open.

**Maintenance**

1. Inspect oil level in gear box / speed reducer and fill with high quality, synthetic lubricant for gears if necessary. Use [Klubersynth UH1 6-460 \(#096060\)](#) or equivalent.
2. Periodically inspect all moving parts, framework and contact areas for signs of wear, fatigue, or loosening. Worn or damaged parts must be properly replaced with the correct , genuine Morse parts.
3. Perform all inspections, load tests, and maintenance according to the ANSI/ASME B30.20 standard.
4. Ensure all labels are in place. Product labels should be inspected periodically and cleaned as necessary to maintain good legibility. Please contact Morse Mfg. Co. for replacement labels.

### Operator's Manual for Morse Model 195GM-A Serial Number 289926 to 291419

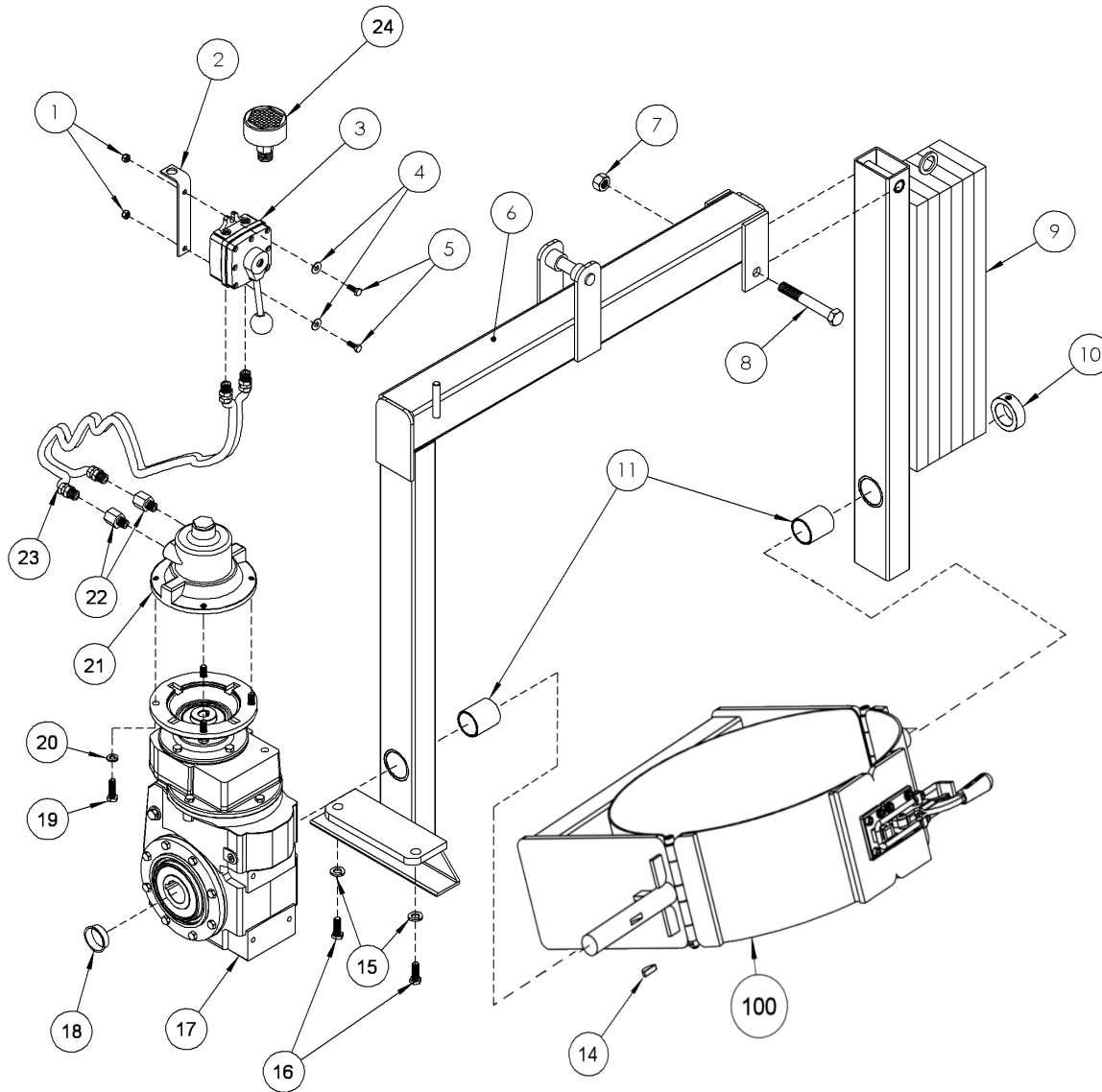

ITEM #	QTY.	PART #	DESCRIPTION
1	2	1518-P	NUT, 1/4-20 NYLON LOCK
2	1	2888-P	MOUNT, CONTROL VALVE, 195GM-A
3	1	2890-P	CONTROL VALVE, 195GM-A
4	2	1866-P	WASHER, 1/4 USS 3/4 OD
5	2	1714-P	HHCS, 1/4-20 X 3/4 GR2
6	1	4196M-P	OVERHEAD WELD, 195AM-A
7	1	1473-P	NUT, 5/8-11 REV HEX LOCK
8	1	565-P	HHCS, 5/8-11 X 4-1/2 GR5
9	1	2854-P	IDLER ARM W/ BEARINGS, 195A
10	1	570-P	COLLAR, 1-1/2" ID
11	2	560-P	BEARING, 1-1/2" ID X 2", GR
14	1	525-P	KEY, WOODRUFF, SIZE F, ASA1211

ITEM #	QTY.	PART #	DESCRIPTION
15	2	1644-P	WASHER, 1/2 SPLIT LOCK
16	2	1502-P	HHCS, 7/16-14 X 1-1/4 GR5
17	1	4067-P	SPEED REDUCER, 195, HELICAL
18	1	3652-P	PLUG, SPEED REDUCER, GR SERIES
19	4	535-P	HHCS, 3/8-16 X 1-1/4 GR5
20	4	1474-P	WASHER, 3/8 SPLIT LOCK
21	1	290-A-2P	MOTOR, 2HP, AIR, 56C
22	2	4676-P	HYD FIT, PIPE ADAPTER 3/8-1/2
23	1	2891-P	HOSE, 12', SELF COILING 195GM-A
24	1	AC980-P	MUFFLER ASM, 290-A-2P, 195
100	1	4511M-P	SADDLE ASM, XMGR, SR, 3PC

**Operator's Manual for Morse Models 195GM-A**  
**Serial Number 289926 to 291419**

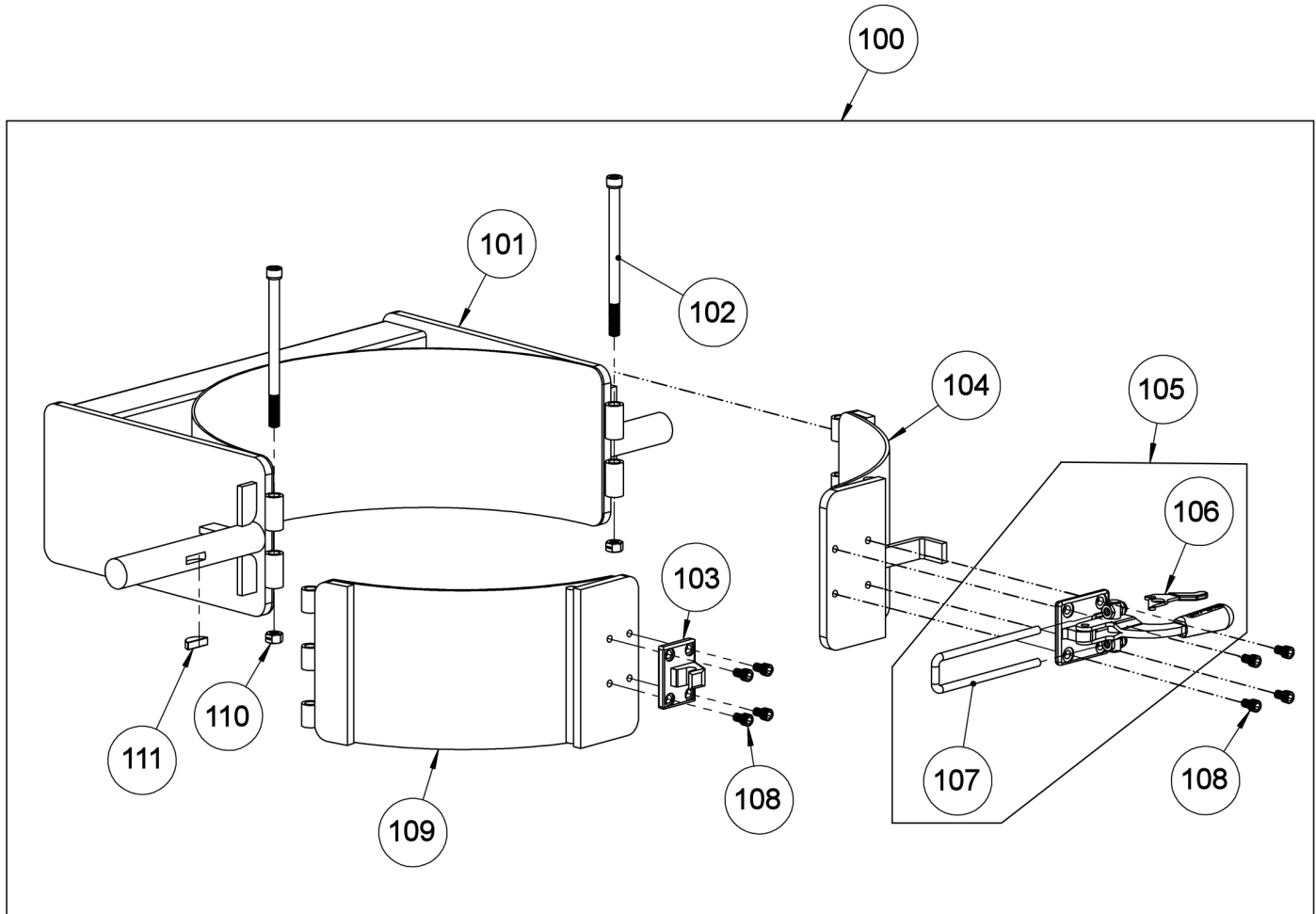

ITEM #	QTY.	PART #	DESCRIPTION
100	1	4511M-P	SADDLE ASM, XMGR, SR, 3PC
101	1	4512M-P	SADDLE WELD, XMGR, SR, 2500LB (NOT SOLD SEPARATELY)
102	2	3592-P	SHCS, 1/2-13 X 7-1/2
103	1	3067-P	CATCH, 375-R TOGGLE, CAMLOCK
104	1	4516M-P	FRONT BAND WELD, CLAMP, XMGR
105 *	1	4187-P	TOGGLE CLAMP, W/ 6" U, GR
106	1	3601-P	RELEASE LEVER, 2984-P
107	1	4682-P	U-BOLT, 6", 375-R CLAMP
108	8	22-P	SHCS, 3/8-24 X 5/8
109	1	4515M-P	FRONT BAND WELD, CATCH, XMGR
110	2	810-P	NUT, 1/2-13 REV HEX LOCK
111	1	525-P	KEY, WOODRUFF, SIZE F, ASA1211

\* Recommended spare parts