

201 SERIES

SPECIFICATIONS SHEET

WHEELED PORTABLE DRUM ROLLERS

Mix Contents of Closed Steel Drum

- Use common steel drum for mixing
- No permanent container to purge between batches
- Use separate drum for each batch

Agitate your drum's contents without opening the drum! Incorporate important stratified ingredients and eliminate sediment in the bottom of your drum. Mixing in closed drums eliminates the hazards, worker exposure, and messy cleanup associated with insertion mixers.

This compact, portable mixer and drum cradle rolls a closed drum to agitate the contents. You may also dispense directly from your drum through a faucet. The built-in tipping bar provides leverage to ease loading and unloading. The sides and back are enclosed to protect the drive.

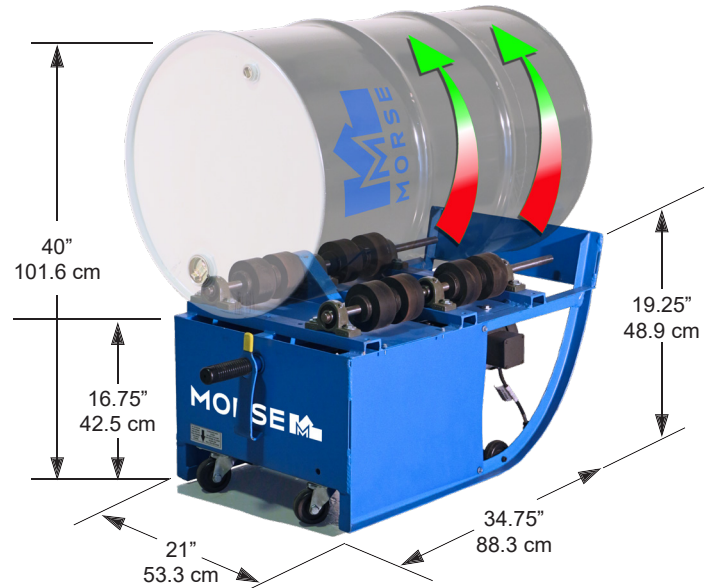

Kick Stand

Deploy Kick Stand to support drum roller in upright position.



Top Rim Hook

Engage Top Rim Hook to help in tipping it over into rolling position.



Rock-Over Loading

Built-in tipping lever facilitates loading. Frame shape and height make loading easier. **Tipping lever engages drum 30" (76.2 cm) or taller.**



Dispense Easily

Drain the contents of a drum directly into a smaller container for use as needed. A closed faucet can be in place while the drum is rotated.

Drum Sizes

- Roll a 6" to 28" (15.2 to 71 cm) diameter drum
- Up to 38" (97 cm) tall. Relocate wheels to accommodate various steel drum sizes.
- The tipping lever will ONLY engage a drum 30" (76.2 cm) or taller

Drum RPM

- Fixed speed models roll a 22.5" (57.2 cm) diameter drum at 20 RPM (16 RPM on 50Hz models)
- Variable speed models roll a drum from 15 to 24 RPM (13 to 20 RPM on 50Hz models)

Capacity of Wheeled Models

- Liquid load: 500 Lb. (227 kg)
- Dry load 300 Lb. (136 kg)

Maximum Ambient Operating Temperature

- 140° F (60° C)

Internal Components

- Large sprockets and roller chain for years of reliable drum rolling.

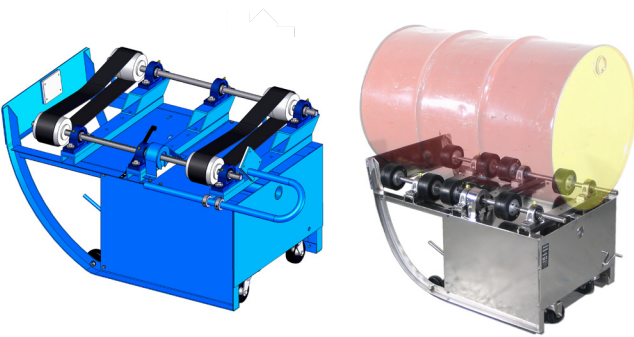

Custom Stainless Steel Portable Drum Rollers

- Custom versions made of type 304 stainless steel are valuable for use in clean environments such as food and pharmaceutical companies.

Belted Drum Rollers Only for FIBER Drum

- Belted portable drum rollers are designed to roll a fiber drum, and can also be used for a steel drum. They have broad belts, instead of the wheels, to support your drum.
- Capacity of Belted Models: 300 Lb. (136 kg)

OPTIONS



Roll a 1 to 5 Gallon Can

Kit # 1-5P

- Install this Idler Attachment kit to extend the usefulness of your drum roller.
- Easily attached with 4 bolts, the spacers adjust to roll a 1 to 5 gallon (4 to 20 liter) cylindrical can.
- Rolls a 5-gallon (20L) can at approximately double the RPM of a 55-gallon (210L) drum.

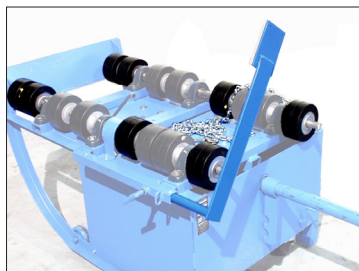

Roll a Plastic Drum

Option # POLY-201

Factory installed option to roll a plastic drum on portable drum roller.

- Extra wheels to support flexible soft-sided plastic drum
- End stop to prevent drum from traveling
- Chain to assist in pulling upright drum over into rolling position

POLY-201 is NOT a drum roller by itself.

Adds 62 Lb. (28.1 kg) to the ship weight and requires a skid.

Kit # POLY-201FI

Kit for customer to install on wheeled 201 Series drum roller.

Steps To Use Portable Drum Roller



A. Extend tipping lever (1) and tilt drum roller to upright



B. Activate kickstand (9) by pulling with foot toward you until locked so drum roller stands by itself



D. Extend tipping lever (1) fully and engage chine hook (2) on top rim of drum



E. To raise kickstand (9) use tipping lever (1) to allow kickstand to clear the floor, and pull yellow release handle (11)



F. Use tipping lever (1) to tilt drum roller over to horizontal rolling position



G. Move drum roller into enclosure (not shown) with interlock, connect power (8) and turn on

H. Once rolling is complete, turn off, disconnect power (8) and remove drum roller from enclosure

I. Extend tipping lever (1) and engage chine hook (2) on top rim of drum

J. Tilt drum roller back to upright and pull kickstand (9) with foot to support drum roller in upright position

K. Remove upright drum with drum truck or below-hook drum lifter

Guard Enclosure Kits with Safety Interlock (Sold Separately)

Comply with OSHA Requirements with a Morse Guard Enclosure Kit (Sold Separately)

Guard Enclosures for Morse Stationary Drum Rollers have a safety interlock to automatically shut off the drum roller when the gate is opened. Open the enclosure gate, place your drum onto the drum roller, then close the gate to allow operation. Connections are included for air powered model only. Control Package options provide controls and connections for AC models.

Install all Morse Rotators in accordance with local requirements for enclosure and safety interlock, etc. One way to accomplish this is with a Morse enclosure with safety interlock, so the rotator

automatically turns off when enclosure door is opened. Power connections and motor controls must also comply with applicable local codes.

For OSHA compliance in the USA, see OSHA subpart O.1910.212 (a)(4) "Barrels, containers, and drums. Revolving drums, barrels, and containers shall be guarded by an enclosure which is interlocked with the drive mechanism, so that the barrel, drum, or container cannot revolve unless the guard enclosure is in place."

GUARD ENCLOSURE KIT #	DESCRIPTION	GATE SWITCH
GEK-201-1	Fits Portable Drum Roller with 1-phase electric motor	AC
GEK-201-3	Fits Portable Drum Roller with 3-phase electric motor	AC
GEK-201-E1	Fits Portable Drum Roller with Explosion-proof 1-phase electric motor	AC
GEK-201-E3	Fits Portable Drum Roller with Explosion-proof 3-phase electric motor	AC
GEK-201-A	Fits Portable Drum Roller with Air motor	Air

* Explosion Proof motors are rated for Class I Group D, and Class II Groups F and G

All Morse Control Packages include a low-voltage transformer and wire terminals required to connect the external safety interlock switch of these Guard Enclosure Kits. Morse Control Packages and Enclosures meet OSHA regulations ONLY when installed properly with safety interlock.

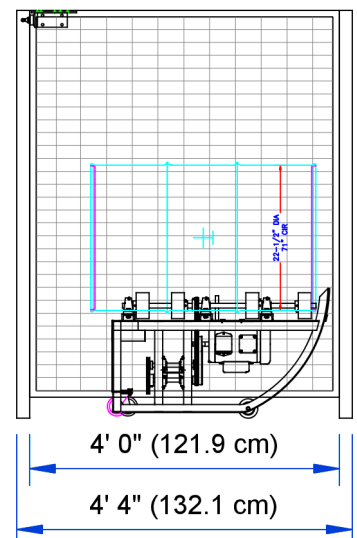
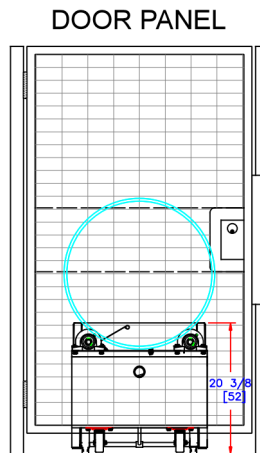
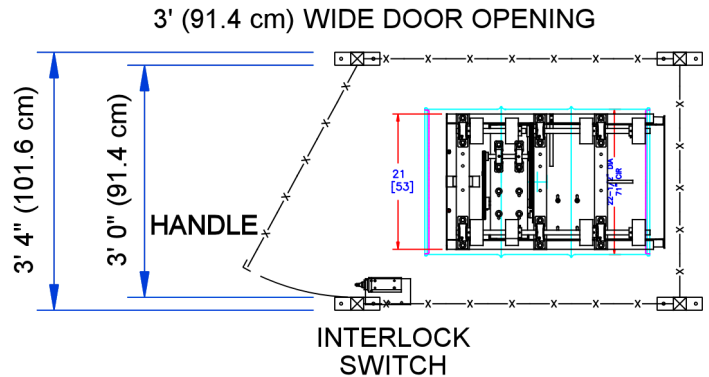
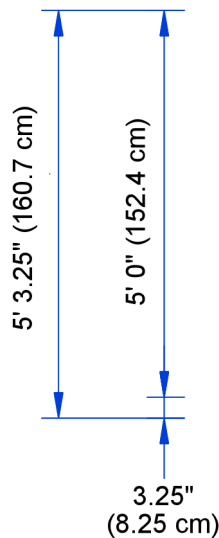
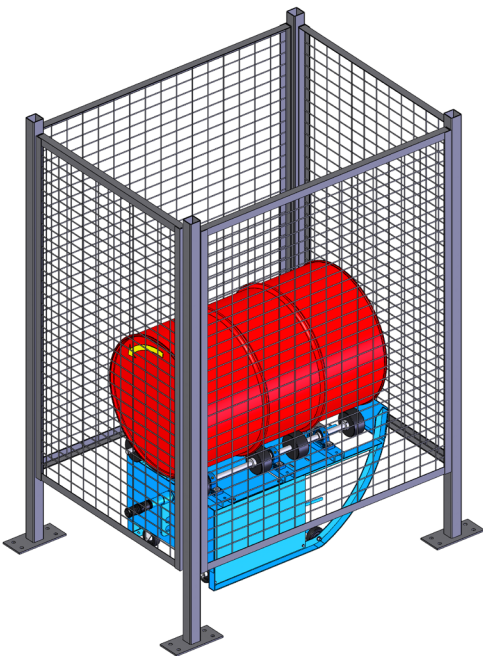



201 SERIES

Wheeled Portable Drum Rollers

SPECIFICATIONS SHEET

Control Station Dimensions for NON-Hazardous Areas

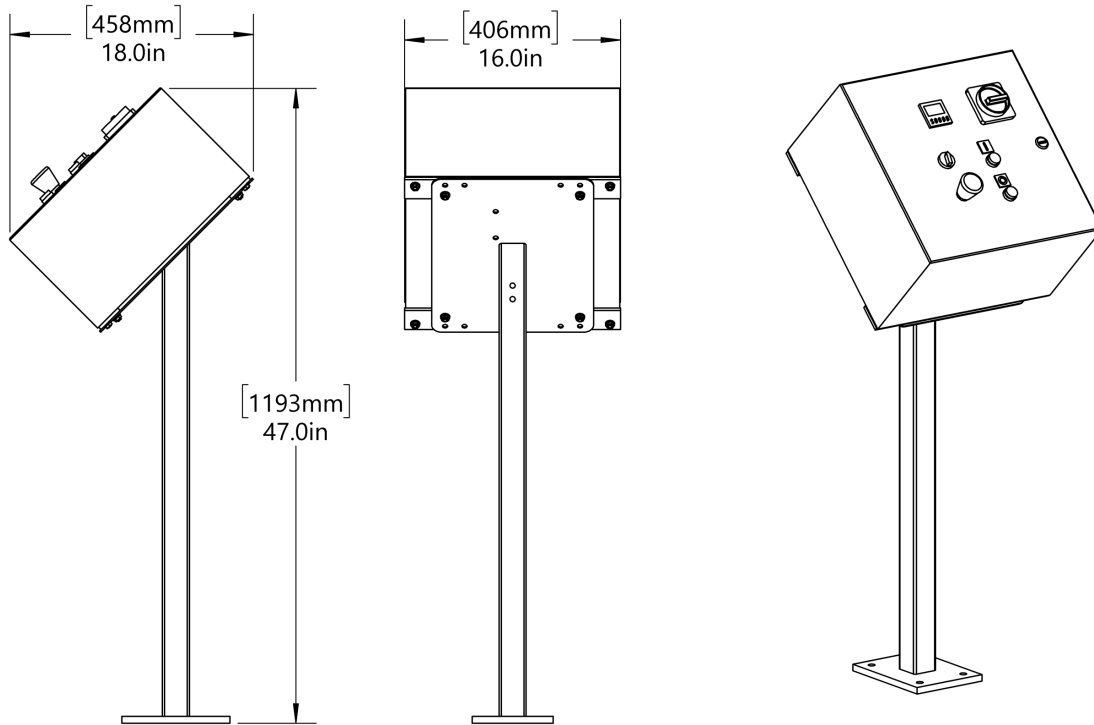

Control Station Dimensions with Explosion-Proof Box for Hazardous Areas

