

Control Dispensing of Dry Materials from Your Drum

Drum Cone - Model 5-VF-45-23
Iris Valve - Kit IV
Clamp Collar - Model 7-23

MADE
IN
USA



- Use drum for controlled dispensing
- Quickly start and stop dispensing with slide gate or iris valve
- Greatly reduce dust when discharging dry materials
- Extend the reach of pour

Use a Morse Drum Cone to Control Dispensing of Dry Materials

Replace your drum lid with a properly sized Morse Drum Cone and Clamp Collar to control dispensing operation by turning your drum into a precise pouring instrument. Morse Drum Cones are designed for controlled dispensing of dry powdered or granulated material, and to reduce dust while discharging. Dispensing can be controlled and stopped with a slide gate or iris valve. Attaching a Morse drum cone to your drum extends the reach of the pour by up to 15.5" (39.4 cm). This can be critical when you need to reach beyond obstructions to reach your container.

Drum Cones have valve flange which allows you to attach an Iris Valve or Slide Gate.

Morse Drum Cones have a 6" (15.24 cm) discharge opening, and are available for standard 30 and 55-gallon (114 and 210 liter) steel drums, and various diameter fiber drums. Specify 45°, 60° angle, or asymmetric drum cone. Choose cone made of carbon steel, or finished type 304 stainless steel. 45° and 60° carbon steel cones for 55-gallon (210 liter) drum are seamless.

All other sizes, and asymmetric and all stainless steel cones are welded. Welds are not ground or polished. Each cone has a neoprene gasket on the flange that comes in contact with the drum rim. Carbon steel cone interior is treated with a rust inhibitor.

Cones are made of 16 gauge carbon steel or type 304 stainless steel.

See model # selection guide on page 2, and [Full list of model numbers online](#).



Drum Cone
Model # 5SS-VF-90-23
Stainless Steel Asymmetric
Drum Cone

Asymmetric Drum Cones

- Only Asymmetric (off-center) Drum Cones can be used with standard Kontrol-Karriers.

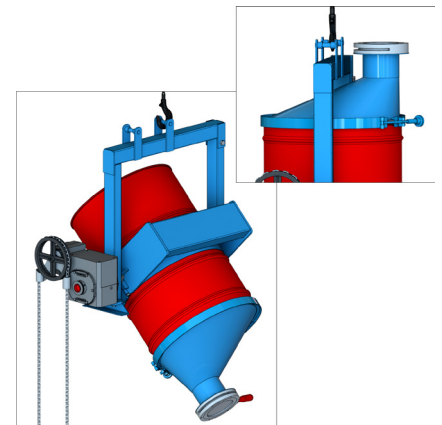

Asymmetric Drum Cone
Model # 5-VF-90-23
with Kit # IV installed

Centered Drum Cones

- **Mobile or Forklift Drum Handlers:** Centered Drum Cones are ideal for use with various mobile and forklift drum handlers, such as Vertical-Lift Drum Pourers, Hydra-Lift Karriers and Forklift-Karriers.
- **Below-Hook Drum Handlers:** Custom [model # 185S-LA](#) Below-Hook Kontrol-Karrier with longer arms provides increased clearance above a 55-gallon (210 liter) drum required for a centered drum cone.
- Standard Kontrol-Karriers lack sufficient clearance within the frame for a centered drum cone.



Stainless Steel Drum Cone (model # 5SS-VF-60-23) with Iris Valve (kit # IV) installed.

Cone size # 23 fits drum rim of 23-3/8" (59.4 cm) outside diameter.



Stainless Steel Asymmetric Drum Cone (model # 5SS-VF-90-23) with Iris Valve (kit # IV) installed. Clamp Collar (model # 7-23) secures cone to drum.

Drum Cones and Clamp Collars

Iris Valve Kit

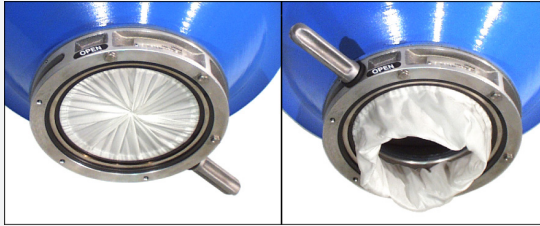

Install aluminum bodied **Iris Valve Kit IV** for controlling flow of fine and coarse materials. Operator revolves handle around valve to open and close flexible sleeve. Valve Sleeve is 4 oz. nylon that is urethane coated. A wide range of fine to coarse materials can be handled without clogging the iris valve. Handle materials with bulk density up to 40 Lb/ft³

Slide Gate Valve Kits

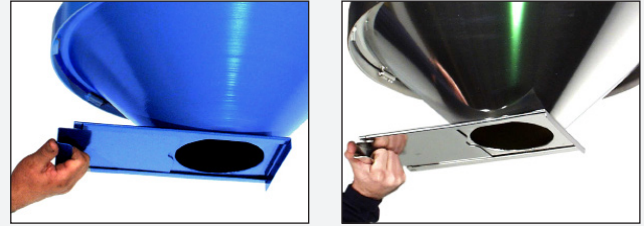

Recommended for coarse granulated products, but NOT for powdered material.

Install **Slide Gate Kit # SG** on carbon steel Drum Cone valve flange. Install **Stainless Steel Slide Gate Kit # SG-SS** on Stainless Steel Drum Cone valve flange.

MADE
IN
USA

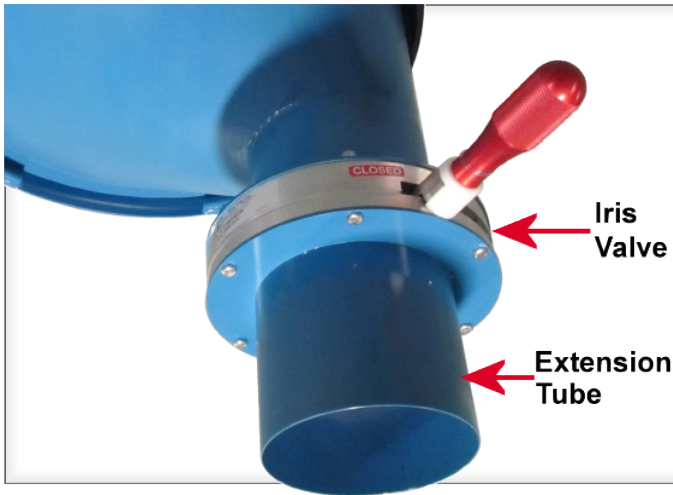

Extension Tubes

Model XT - 5" (12.7 cm) Extension Tube

Model XT-SS - Stainless Steel 5" Extension Tube (not shown)

Install Extension Tube ONLY on Drum Cone Valve Flange or Iris Valve.

Extension Tubes are NOT for use with Slide Gate Valve.

Shown here with:

- Asymmetric Drum Cone - Model 5-VF-90-23
- Iris Valve to control material flow - Model IV

Morse Clamp Collars to secure the Drum Cone to your drum

Order a Clamp Collar to secure the cone in position onto the top of your drum. When ordering cones or clamp collars, please specify the outside diameter of the top drum rim. Remove the drum lid and take several measurements across the rim at various points and calculate the average. See selection guide below.



Tighten the Clamp Collar around the top rim of drum with the Drum Cone in place. On the inside of the Clamp Collar there are sections of steel rod to retain the Drum Cone, and sections of angle iron to engage under the drum top rim. Tighten the Clamp Collar by turning the knob on the end of the threaded rod.

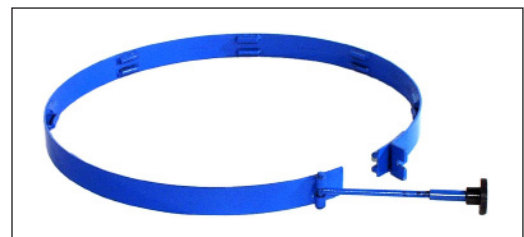

Model 7-23 Clamp Collar carbon steel painted blue, size # 23



Model 7SS-20 Clamp Collar made of type 304 stainless steel, size # 20

Drum Cone Selection Guide

Select a Drum Cone

- Cone Material:** Choose stainless steel (SS), or leave blank for regular steel painted blue.
- VF = Valve Flange**
- Angle of Cone:** Choose 45° or 60° based on flow characteristics of material in your drum and height restrictions within your application. Choose 90° for Asymmetric drum cones with off-center 6" discharge opening.
- Size #:** Determine Cone Size #
 - Identify drum type (steel or fiber).
 - Measure the top rim outside diameter of your drum.
 - Remove your drum lid before measuring.
 - Measure outside diameter across the rim at several points.
 - Calculate the average rim outside diameter.
 - Select the Cone Size # for your drum type and rim diameter.

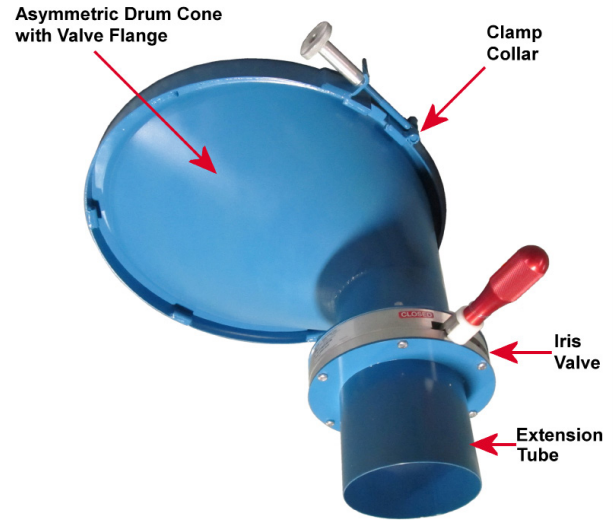

MADE IN USA

Steps to Select

Drum Cone Model # → 1 2 3 4

Cone Model # - - -

Clamp Collar Selection Guide

Select the Matching Clamp Collar

- Collar Material:** Choose stainless steel (SS) or regular steel.
- Size #:** Select Size # corresponding to the Size # of your cone.

Clamp Collar Model # → 1 2

Clamp Collar Model # -

Key to Cone Model Numbers

	Cone Series #	Cone Material	Valve Flange	Angle of Cone	Size #
Example:	5	SS	VF	45	23
		SS = Stainless Steel Blank = Regular Steel	VF = Valve Flange	45 = 45° Angle 60 = 60° Angle 90 = Asymmetric	
					23
					21.5
					20
					19
					18.5
					17
					15.5

NOTE: Customized cones to fit a non-standard drum size or type can be ordered as Model 5S, but are not in this chart. Custom Clamp Collars are available as Model 7S.

Fits Drum

Drum Type	Drum Rim Diameter (You Measure)
55-Gal. Steel or Fiber	23-3/8" (59.5 cm)
Fiber	21-7/8" (55.6 cm)
Fiber	20-3/8" (51.75 cm)
30-Gal. Steel	19-1/8" (48.6 cm)
Fiber	18-7/8" (47.9 cm)
Fiber	17-3/8" (44.1 cm)
Fiber	15-7/8" (40.3 cm)

Key to Clamp Collar Model

Collar Series #	Collar Material	Size #
Example: 7	SS	23
		23
		21.5
		20
		19
		18.5
		17
		15.5

SS = Stainless Steel
Blank = Regular Steel

Valves to Fit Drum Cone Valve Flange

- Kit # IV = Aluminum Bodied Iris Valve
- Kit # SG = Slide Gate
- Kit # SG-SS = Stainless Steel Slide Gate

Drum Cone Dimensions

Each Morse Drum Cone has a 6" (15.24 cm) diameter discharge opening.

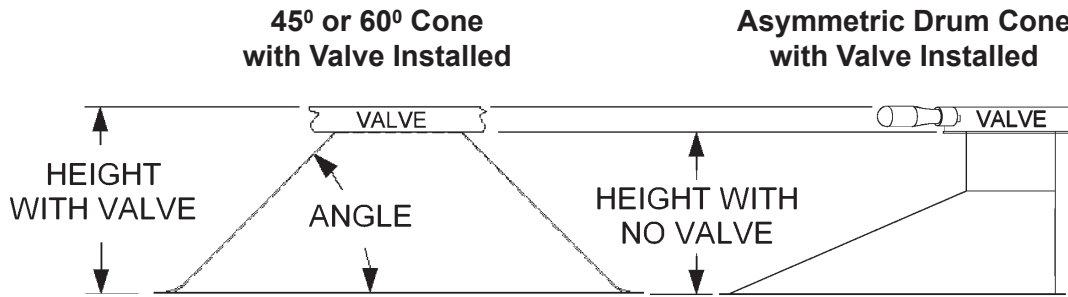

MADE
IN
USA

Approximate Height of Drum Cones						
Size #	45° Angle Drum Cone		60° Angle Drum Cone		Asymmetric Drum Cone	
	Height with No Valve	Height with Valve	Height with No Valve	Height with Valve	Height with No Valve	Height with Valve
23	8" (20.3 cm)	9.5" (24.1 cm)	14" (35.6 cm)	15.5" (39.4 cm)	11" (27.9 cm)	12.5" (31.75 cm)
21.5	7.5" (19.1 cm)	9" (22.9 cm)	12.5" (31.75 cm)	14" (35.6 cm)	11" (27.9 cm)	12.5" (31.75 cm)
20	7" (17.8 cm)	8.5" (21.6 cm)	11.5" (29.2 cm)	13" (33 cm)	11" (27.9 cm)	12.5" (31.75 cm)
19	6" (15.24 cm)	7.5" (19.1 cm)	10.5" (26.7 cm)	12" (30.5 cm)	11" (27.9 cm)	12.5" (31.75 cm)
18.5	6" (15.24 cm)	7.5" (19.1 cm)	10" (25.4 cm)	11.5" (29.2 cm)	11" (27.9 cm)	12.5" (31.75 cm)
17	5.5" (14 cm)	7" (17.8 cm)	9" (22.9 cm)	10.5" (26.7 cm)	11" (27.9 cm)	12.5" (31.75 cm)
15.5	4.5" (11.4 cm)	6" (15.24 cm)	7.5" (19.1 cm)	9" (22.9 cm)	11" (27.9 cm)	12.5" (31.75 cm)

Measure Drum Rim Outside Diameter

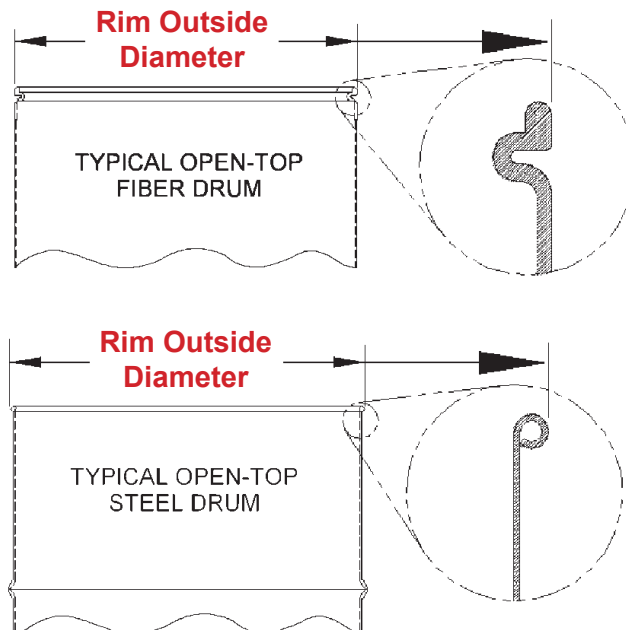

Drum Cone Valve Flange Dimensions

Dimensions of flange to attach Valve or Extension Tube

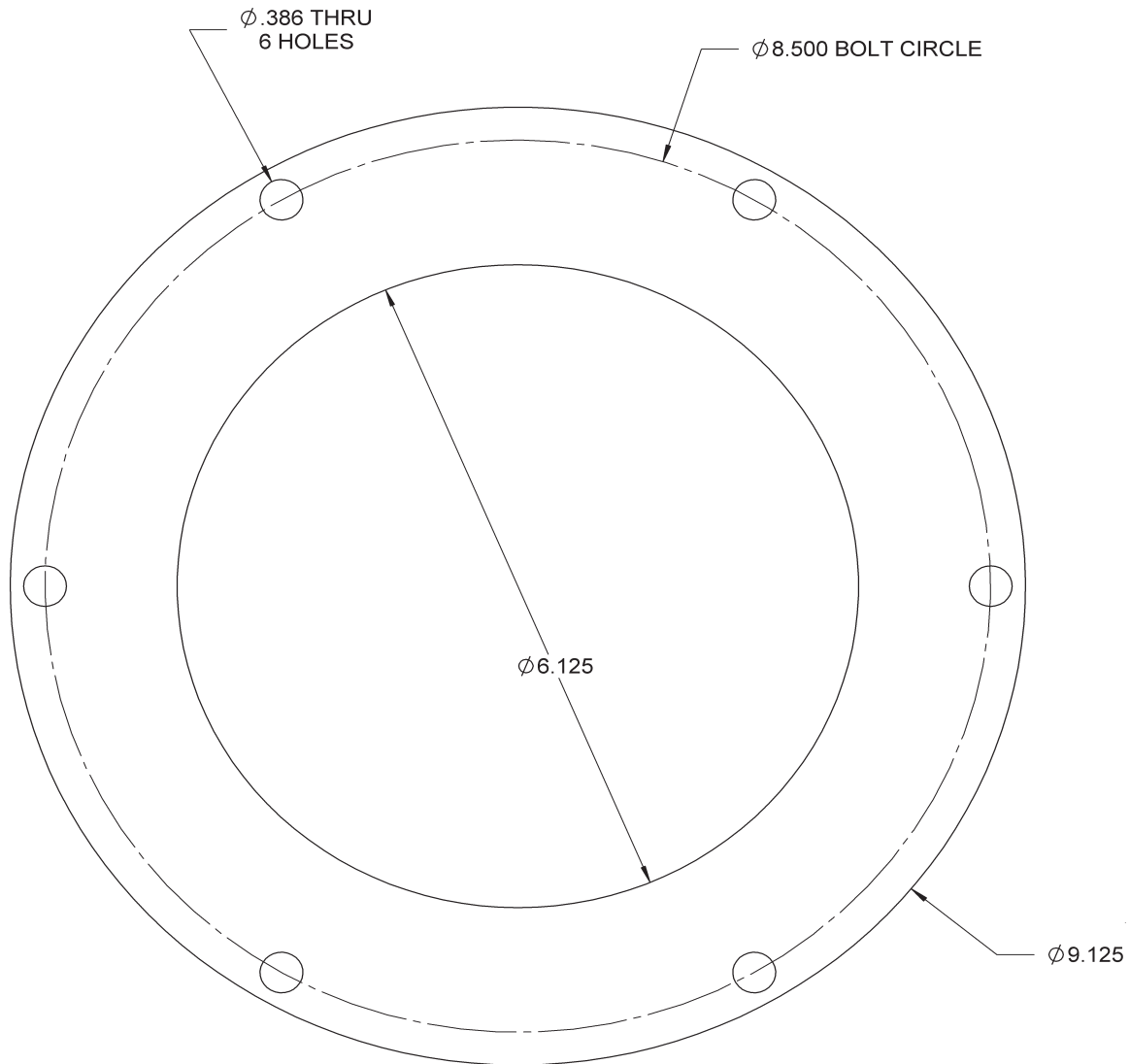

MADE
IN
USA