

CONTENTS

- Receiving Procedures
- Warranty
- Safety Information
- Machine Description
- Installation Instructions
- Operating Instructions
- Maintenance

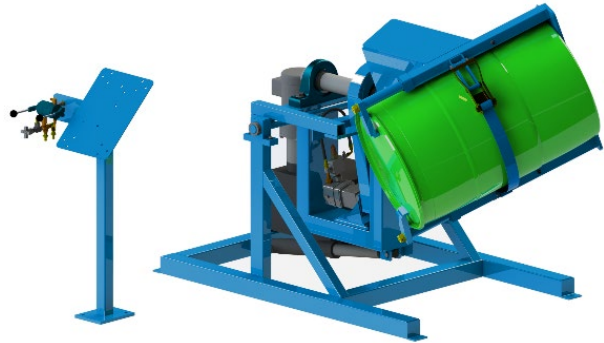

Receiving Procedures

Every Morse drum handler is inspected prior to shipping. However, damage may be incurred during transit.

- Check for visible damage. If you choose to accept damaged freight, always sign noting the damage on the **BILL OF LADING**.
- Document the damage and have the truck driver sign. We recommend keeping a digital camera at your receiving dock for this purpose.
- Open packages expeditiously to check the condition of the goods. There is only a 24 hour window to notify the carrier of any concealed damage.
- **IMMEDIATELY REPORT ALL DAMAGE TO THE SHIPPING COMPANY!** Then you may contact Morse for assistance with your freight claim.
- Morse Manufacturing will not be held responsible for any damaged freight that is not signed for as damaged.

Delivery to non-business addresses without a loading dock result in additional freight charges. Residential delivery fees, inside delivery fees, re-delivery charges, and lift gate services will be added by the truck line, and are non-negotiable.

Limited 2 Year Warranty

Morse drum handling equipment is guaranteed against defects in workmanship or materials for **TWO YEARS** when used properly within its rated capacity. Warranty does not cover wear from normal use or damage from accident or abuse. Motors and other purchased parts carry the warranties of their manufacturers.

For warranty claims, contact your Morse Dealer to obtain a return authorization number, and for return freight advice. Return freight must be prepaid.

In all instances, liability is limited to the purchase price paid or to repairing or replacing the product. Customer assumes liability for any modifications, unauthorized repairs or parts substitution.

Safety Information

While Morse Manufacturing Co. drum handling equipment is engineered for safety and efficiency, a high degree of responsibility must be placed upon the machine operator to follow safe practices, based primarily on common sense, upon which true safety depends.

Failure to follow the safety precautions in this manual can result in personal injury or property damage. Observe the same precautions as with similar machinery where carelessness in operating or maintenance is hazardous to personnel. Carefully read the safety precautions below and throughout this manual.

Review the Material Safety Data Sheet(s) for the material(s) in the drum(s) and take all necessary precautions. Safety shoes, work gloves, hard hat and other personal protective devices are recommended.

Prior to initial use, inspect all moving parts and test rotation of drum holder with a weighted drum. Do NOT raise drum holder without a load, as it may become stuck due to the tight seals in the cylinder. Inspect drum holder for proper operation. Perform necessary inspections, operator training, etc.













DANGER - Indicates a situation which, if not avoided, will result in serious injury or death. This signal word is limited to the most extreme situations.



WARNING - Indicates a situation which, if not avoided, could result in serious injury or death.



CAUTION - Indicates a situation which, if not avoided, can result in damage to the machine.

		<p>DANGER - Watch Out for Pinch Points. Stay clear of moving parts. Do Not Stand Near any Part of a Rotating Drum or Drum Holder. Operator should remain directly in front of the control station while operating the Tumbler. Morse Drum Tumblers do not comply with OSHA unless they are installed in accordance with OSHA subpart O, 1910.212 - "General requirements for all machines." "Revolving drums, barrels, and containers shall be guarded by an enclosure which is interlocked with the drive mechanism, so that the barrel, drum, or container cannot revolve unless the guard enclosure is in place." (An optional safety enclosure can be ordered for any MORSE drum rotator.)</p>
	<p>WARNING - The 310 Series is designed to rotate a steel, plastic or fiber drum weighing up to 800 Lb. (363 kg), ranging from 18" to 23.5" (45.7 to 59.7 cm) in diameter and from 29" to 37" (74 to 94 cm) in height. DO NOT attempt to handle any other type of drum or object. DO NOT exceed the weight capacity of 800 Lb. (363 kg).</p>	
	<p>WARNING - Level Floors Only. For operation only on clean, level floors of suitable bearing capacity. Do not use on sloped surfaces, ramps, irregular or debris strewn floors.</p>	
	<p>WARNING - Properly Mount to Floor. Do Not put into service without proper floor mounting and leveling. Use the four mounting holes in each corner of the base to anchor to floor.</p>	
	<p>WARNING - Do Not Modify the Unit. Under no circumstances should any modifications be made to the Morse machinery without factory authorization. Any modifications may void the warranty. This machine was designed to perform a specific job and alterations may result in injury to operator or machine.</p>	
	<p>WARNING - No Loose Fitting Clothing. Wear close-fitting clothing and safety equipment appropriate to the job. Loose fitting clothing may become caught on the machinery and cause severe personal injury.</p>	
	<p>CAUTION - Wear safety shoes with non-slip soles and hard toe protection.</p>	
	<p>CAUTION - DO NOT allow drum to impact on floor, ground, etc.</p>	
	<p>WARNING - Hydraulic Fluid Under Pressure Can Be Hazardous. Escaping hydraulic fluid under pressure can penetrate the skin, causing serious injury. Avoid the hazard by relieving pressure before disconnecting hydraulic lines. Keep hands and body away from pinholes and nozzles which eject fluid under high pressure. Use a piece of cardboard to search for leaks. If an accident occurs, see a doctor immediately and inform them of the nature of the accident.</p>	
	<p>WARNING - This product can expose you to chemicals including barium sulfate, cobalt, titanium dioxide, and 2-methylimidazole, which are known to the State of California to cause cancer, and bisphenol-A, which is known to the State of California to cause birth defects or other reproductive harm. For more information go to www.P65Warnings.ca.gov</p>	

Machine Description

The Morse 310 Series Tilt-to-Load Drum Rotators are designed to receive an upright steel, plastic or fiber drum at floor level, hydraulically tilt up to clear the floor, and rotate the drum "corner-over-corner". The maximum full drum capacity is 800 Lb. (363 kg). Capacity is derated to 400 Lb. (181 kg) for a half-full drum. Half-full Capacity is an indication of the capacity for tilting a bottom-heavy drum. A partially full drum with an unbalanced and shifting load is harder to tilt than a full drum.

MORSE
Mfg. Co., Inc.
E. Syracuse, NY

The Specialist in Drum Handling Equipment

800

(363 kg)

Lb. Max. Capacity

Made in U.S.A.

Controls

There are two powered functions for the operator to control. Each function is controlled separately by levers mounted on the control station.

1. The "LIFT" function, for vertical positioning of the drum holder. The lever on the right side is the "LIFT" control valve. Raising the lever causes the drum holder to rise. Lowering the lever will lower the drum holder.

2. The "ROTATE" function, or the rotation of the drum holder. The lever on the left side is the "ROTATE" control valve. Raising this lever causes the drum holder to rotate. Lowering the lever away from the operator will stop the drum holder from rotating. The rotation speed can be varied with the metering valve (item 6 on page 9). Turn the valve clockwise to increase speed counterclockwise to decrease speed.

Drum Holder

The drum holder is the component on the Tilt-To-Load Drum Rotator that securely holds the drum for rotating. The drum holder features the web strap and ratchet mechanism for tightening the drum at the middle and two top clamps for holding the drum end-to-end.

Installation

- Hydraulic fluid: Tilt-To-Load Rotators are shipped filled with hydraulic fluid (Dexron 3 or equivalent). Replace the RED shipping plug from the hydraulic reservoir with the supplied BLACK breather, and install hydraulic levers BEFORE operation.
- The base has four holes spaced 36" (91.44 cm) wide x 59.5" (151.13 cm) long. Morse recommends the rotator be secured to the floor using 5/8" x 3" lag bolts.
- Install all Morse Rotators in accordance with OSHA requirements for enclosure and safety interlock, etc. Drum rotator must automatically turn off when enclosure door is opened.
- Control Station - Making Connections:

Installation Continued

AC Powered Models

- Jog the motor to check rotation. Motor fan must turn clockwise.
- To reverse rotation if necessary
 - For 3 phase motors: interchange any two input leads.
 - For 1 phase motors: interchange wires 5 & 8 in junction box.

AIR Powered Model

- For the air motor powered rotator, a filter, regulator, lubricator is mounted on the control station. A shutoff ball valve is installed on the inlet of the regulator. The air connection should be made at the inlet of this valve.
- Ensure that the supply air lines are of sufficient size to provide proper air volume. The air motor requires 60 scfm, and 50 – 60 psi of compressed air. The proper air pressure will depend on the weight of the drum.

See Air Motor Technical Info at:

<http://www.morsemfgco.com/ops/PLAIR.pdf>

- **Prior to initial use**, inspect all moving parts and test rotation of drum holder with a weighted drum. Do NOT raise drum holder without a load, as it may become stuck due to the tight seals in the cylinder.

Important

1. Review the Material Safety Data Sheet(s) for the material(s) in the drum(s) and take all necessary precautions. Safety shoes, work gloves, hard hat and other personal protective devices are recommended.
2. Please read all instructions thoroughly before attempting to operate your new Morse drum handler.
3. When loading, unloading, operating, or maintaining your MORSE drum handler, always use care and good judgment. Maintain secure footing and a firm hold. Keep hands and loose clothing away from all moving parts. Never allow anyone to be below any part of a raised drum handler or drum. Read operating instructions and review the pictures in the sales brochure before operation.

Operating Instructions

Loading a Drum

1. With the drum holder in the lowered position, the bottom loading plate will be slightly above the floor. Swing the hinged ratchet plate clear of the drum opening. Loosen the top clamps to the full open position.
2. A variety of drum handling methods can be used to set the drum into the drum holder. Ensure that the drum is fully seated against the back of the drum holder.



Load drum with drum Ruck



Load with Model 81 Drum Spotter



Load Drum with Hoist attachment



3. Drape the web strap across the face of the drum, and thread through slot in ratchet. Operate ratchet to tighten strap around drum.



4. Turn the top clamps until they tighten against top of drum. Then remove hand crank **BEFORE** rotating drum.

Rotating a Drum

1. After ensuring that the drum is securely fastened into the drum holder, turn the motor on to activate the hydraulics (for the air motor version, open the air shutoff ball valve).

2. Raise the drum to the top position by raising the "LIFT" lever, on the right.
Note: There is an interlock switch built into the tilt frame which is intended to prevent rotating when the drum holder is not properly positioned at its highest lift point. The true safety of this operation, however, depends on the operator correctly positioning the drum holder, and verifying that the tilt frame is fully raised.



 **DANGER** - It is critical that the drum holder assembly is fully raised BEFORE rotating. If the drum holder is not in the fully raised position when rotating, it can interfere with the floor and frame, causing severe damage to equipment and/or serious injury or death

3. To begin rotating, raise the "ROTATE" lever.

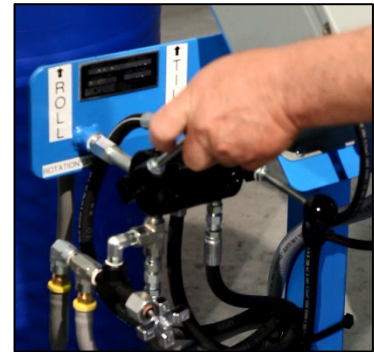

4. The drum rotation speed can be varied with the metering valve. Turn the valve clockwise to increase speed counter-clockwise to decrease speed.

Alternate method on the air motor version: With the air shutoff ball valve in the OFF position, raise the ROTATE valve to the ROTATE position. Then, slowly open the air shutoff ball valve to begin the rotation. This can allow for more control over the speed of rotation.

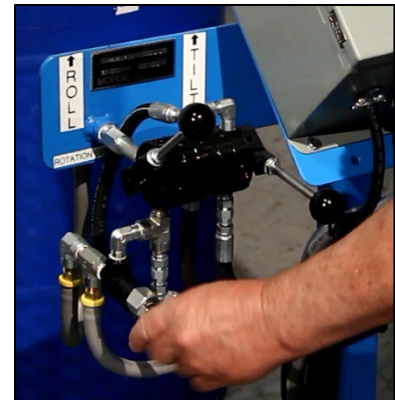

Unloading a Drum

Ensure the drum is in upright position to unload.

1. Squeeze the ratchet release lever and open all the way to unlock, then release the tension on the strap. Allow enough slack in the strap in order to remove from ratchet.
2. Loosen top clamps and swing clear of drum.
3. Remove drum with appropriate drum handling equipment.

Preventative Maintenance

Periodic inspection for the general condition of structural and mechanical components is imperative for safe and efficient operation.

Monthly

Inspect the hydraulic system for oil drips, hose damage, or other signs of wear. Inspect the level and condition of the hydraulic fluid.

Hydraulic fluid level should be within a ½" of the top of the reservoir when the cylinder is in the retracted position. Replace any parts that show signs of wear.

Inspect all moving parts, framework, ratchet, web strap, fasteners and contact areas for signs of wear, fatigue, or loosening. The web strap should be removed from service and replaced if any of the following are visible:

- Acid or caustic damage
- Melting or charring of any part of the strap
- Holes, tears, cuts, snags or embedded articles
- Broken or worn stitching in load bearing splices
- Excessive abrasive wear

Every 6 to 12 Months in Ordinary Environment (monthly in dirty conditions)

Lubricate all moving parts.

Pillow Block Bearings. See Bearing Lubrication Sheet for grease types and fill amounts at:

https://morsedrum.com/ops/2654-P_bearing-grease.pdf

Drive chain: Grease with multiservice lubricant such as

Whitmore's Surtac® 2000 HD shown at:

https://morsedrum.com/ops/SDS_5358-P_WHITMORE-Surtac-2000-HD_Mar_2019.pdf

Clamp Screws: Grease every 6-12 months with multiservice lubricant e.g. Whitmore's Surtac® 2000 HD shown at:

https://morsedrum.com/ops/SDS_5358-P_WHITMORE-Surtac-2000-HD_Mar_2019.pdf

Yearly

Hydraulic Pump: Change oil with 6 gallons of ATF Dexron III or equivalent. For more oil information, see maintenance information of Hydraulic Pump Sheet at:

<https://morsedrum.com/ops/PLM404-310-P.PDF>

Tilt Assembly (Not Sold Separately)

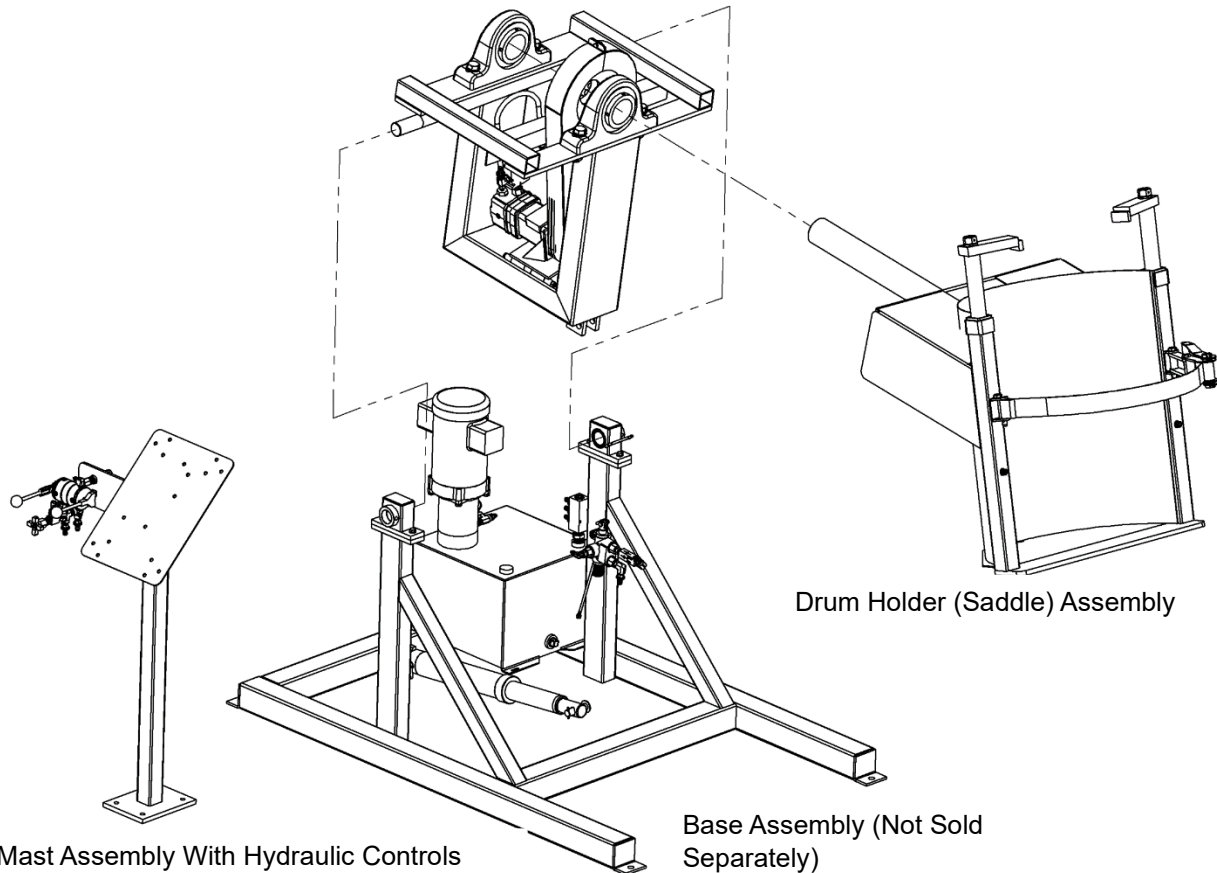

Mast Assembly With Hydraulic Controls
(Part 5762-P)

Base Assembly (Not Sold Separately)

Drum Holder (Saddle) Assembly