

## CONTENTS

- Receiving Procedures
- Warranty
- Safety Information
- Machine Description
- Accessories
- Start-Up Procedure
- Operating Instructions
- Maintenance

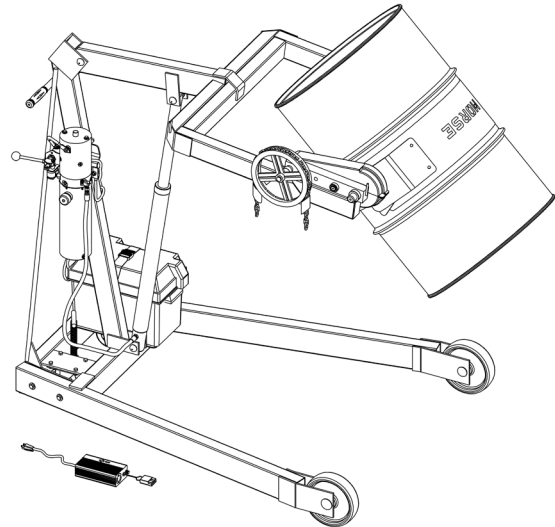

### Receiving Procedures

Every Morse drum handler is inspected prior to shipping. However, damage may be incurred during transit.

- Check for visible damage. If you choose to accept damaged freight, always sign noting the damage on the **BILL OF LADING**.
- Document the damage and have the truck driver sign. We recommend keeping a digital camera at your receiving dock for this purpose.
- Open packages expeditiously to check the condition of the goods. There is only a 24 hour window to notify the carrier of any concealed damage.
- **IMMEDIATELY REPORT ALL DAMAGE TO THE SHIPPING COMPANY!** Then you may contact Morse for assistance with your freight claim.
- Morse Manufacturing will not be held responsible for any damaged freight that is not signed for as damaged.

Delivery to non-business addresses without a loading dock result in additional freight charges. Residential delivery fees, inside delivery fees, re-delivery charges, and lift gate services will be added by the truck line and are non-negotiable.

### Limited 2 Year Warranty

Morse drum handling equipment is guaranteed against defects in workmanship or materials for **TWO YEARS** when used properly within

its rated capacity. The warranty does not cover wear from normal use or damage from accident or abuse. Motors and other purchased parts carry the warranties of their manufacturers.

For warranty claims, contact your Morse Dealer to obtain a return authorization number, and for return freight advice. Return freight must be prepaid.

In all instances, liability is limited to the purchase price paid or to repairing or replacing the product. Customer assumes liability for any modifications, unauthorized repairs or parts substitution.

### Safety Information

While Morse Manufacturing Co. drum handling equipment is engineered for safety and efficiency, a high degree of responsibility must be placed upon the machine operator to follow safe practices, based primarily on common sense, upon which true safety depends.

Failure to follow the safety precautions in this manual can result in personal injury or property damage. Observe the same precautions as with similar machinery where carelessness in operating or maintenance is hazardous to personnel. Carefully read the safety precautions below and throughout this manual.













**DANGER** - Indicates a situation which, if not avoided, will result in serious injury or death. This signal word is limited to the most extreme situations.



**WARNING** - Indicates a situation which, if not avoided, could result in serious injury or death.



**CAUTION** - Indicates a situation which, if not avoided, can result in damage to the machine.

		<b>CAUTION – Do Not Transport with Drum Raised</b> - ALWAYS LOWER THE DRUM HOLDER TO LOWEST POSITION BEFORE TRANSPORTING. The unit can become unstable when transporting with a raised load.
		<b>DANGER - Stay Clear of Power Lines</b> KEEP WELL CLEAR OF POWER LINES. Never approach a power line. Current in a high voltage line may arc some distance from the wire to the steel framed, grounded machine.
		<b>WARNING</b> - The Hydra-Lift Karrier is designed to handle one drum of the types listed in the Machine Description. DO NOT attempt to handle any other type of drum or object. DO NOT exceed the weight capacity 800 Lb. (363kg).
		<b>WARNING - Do Not Modify the Unit</b> - Under no circumstances should any modifications be made to the Morse machinery without factory authorization. Any modifications may make the warranty. This machine was designed to perform a specific job and alterations may result in injury to the operator or machine.
		<b>WARNING – Level Floors Only</b> - For operation only on clean, level floors of suitable bearing capacity. Do not use sloped surfaces, ramps, irregular or debris strewn floors.
		<b>WARNING - No Loose Fitting Clothing</b> - Wear close-fitting clothing and safety equipment appropriate to the job. Loose fitting clothing may become caught on the machinery and cause severe personal injury.
		<b>CAUTION - Hydraulic Fluid Under Pressure Can Be Hazardous</b> Escaping hydraulic fluid under pressure can penetrate the skin, causing serious injury. Avoid the hazard by relieving pressure before disconnecting hydraulic lines. Keep hands and body away from pinholes and nozzles, which eject fluid under high pressure. Use a piece of cardboard to search for leaks. If an accident occurs, see a doctor immediately and inform them of the nature of the accident.
		<b>CAUTION - Wear Safety Shoes</b> - Wear safety shoes with non-slip soles and hard toe protection.
		<b>WARNING</b> - This product can expose you to chemicals including barium sulfate, cobalt, titanium dioxide, and 2-methylimidazole, which are known to the State of California to cause cancer, and bisphenol-A, which is known to the State of California to cause birth defects or other reproductive harm. For more information go to <a href="http://www.P65Warnings.ca.gov">www.P65Warnings.ca.gov</a>
		<b>WARNING</b> - This product can expose you to chemicals including lead and arsenic, which are known to the State of California to cause cancer and birth defects or other reproductive harm. For more information go to <a href="http://www.P65Warnings.ca.gov">www.P65Warnings.ca.gov</a> .

## Machine Description

Model 400A-96-125 Hydra-Lift Karrier will pour a drum up to 96" (244 cm) high, measured from the floor to the lowest point of a horizontal drum. It is designed to lift, transport, and dispense a 55-gallon (210 liter) steel drum 22" to 23.5" (56 to 59.7 cm) in diameter.

Maximum full-drum capacity is 800 Lb. (363 kg). Capacity is derated to 500 Lb. (227 kg) for a half-full drum. Half-full rating is based on the tilt mechanism's capacity for handling an unbalanced bottom-heavy drum.



## Controls

The Morse Hydra-Lift Karrier is manually propelled and steered. The drum lift is powered by a 12V DC motor. There are two functions for the operator to control:

1. LIFT and Lower Function to raise and lower the drum
  - See Hydraulic Power Pack manual for operating instructions and other pertinent information.
2. TILT Function to tilt the drum
  - Pull down on one side of chain, rotating drum to angle required for pouring.
  - For best control of drum pouring angle, pay out one side of the chain loop while pulling in the other side. This helps you to hold back the drum rotation if the contents of the drum shift.
  - The pull chain pin on the corner of the overhead assembly can be used to prevent drum rotation. Simply "tie-off" the chain by engaging in into the pin.
  - If the drum handler is equipped with the MORStop Tilt-Brake, there is no need to hold tension on both sides of the chain loop. Braking is immediate and self-actuating, without additional steps by the operator. To add the MORStop Tilt-Brake to your drum handler, order part # 3900-P for a field installation kit.



**WARNING** - Watch Out for Pinch Points Stay clear of moving parts. Operator should remain behind the push handle during the lift operation.

### Floor Lock

The screw-down floor lock is located on the base of the tower (figure 3.1). Turning the floor lock clockwise until it locks in the down position activates the floor lock. When the floor lock is activated, it prevents unwanted freewheeling of the unit. Floor conditions determine the effectiveness of the floor lock. The operator should verify its holding action before depending on it to hold.

### Drum Holder (Saddle) Assembly

The MORCINCH Drum Holder (Saddle) assembly is the component intended to hold the drum. It is designed to secure a standard ribbed 55-gallon (210 liter) steel drum around its middle using a cinch chain and ratchet tightening system. It automatically adjusts for 22" to 23.5" (56 to 59.7 cm) diameter drum.

The MORCINCH Drum Holder also accepts accessories to handle a plastic drum, fiber drum, or a smaller diameter drum.

Figure 3.1

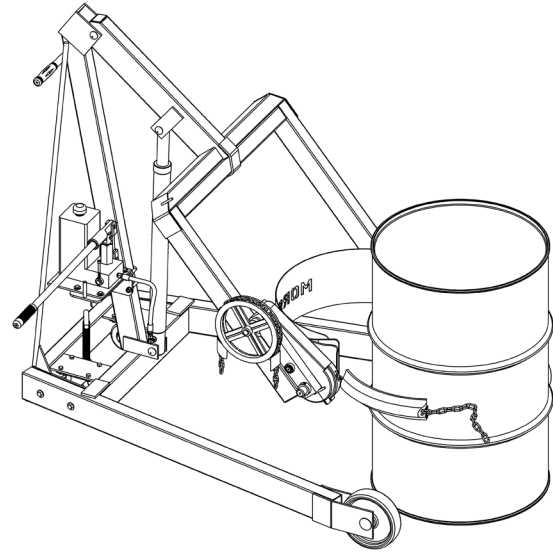

### START-UP Procedure

1. The machine is shipped with hydraulic fluid. Install provided hydraulic control levers (threaded rods with black ball handles).
2. **IMPORTANT:** BEFORE operation, remove the **RED** shipping plug from the hydraulic reservoir, and replace it with the provided **BLACK** breather.

### Operating Instructions

1. Push the Hydra-Lift Karrier to the drum.
2. Using the "LIFT" control as described in "Machine Description Controls" position the drum holder assembly with the back band at the middle of the drum (Figure 3.1). With the ratchet plate swung open and the cinch chain hanging from the chain hook, push the unit until the back band rests firmly against the drum. Some adjustment to the tilt angle of the saddle may be necessary to ensure band fits flush on the drum.
3. **Attaching the drum:** Drape the chain across the front of the drum and engage a link into the notch in the ratchet (Figure 3.2). Turn the ratchet clockwise to tighten the chain. If the ratchet turns until the pawl is beyond the last ratchet tooth, turn the ratchet back and slide the next link into the ratchet notch and try tightening again. The chain must be held tightly

Figure 3.2

against the drum with the pawl engaged securely in the ratchet teeth.

4. Operate the lift function to lift drum clear of floor. Roll to dispensing location. NOTE: Do not allow the drum to impact on floor, pouring station, etc. or a spill or damage could occur.

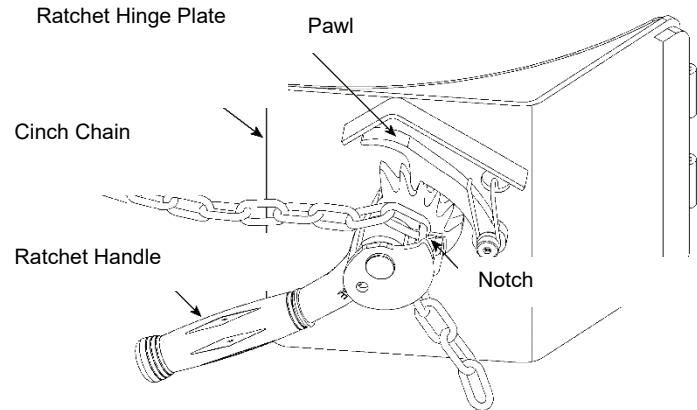

**CAUTION** – Do Not Transport with Drum Raised ALWAYS LOWER THE DRUM HOLDER TO LOWEST POSITION BEFORE TRANSPORTING. The unit can become unstable when transporting with a raised load.

5. Lift drum to desired pouring height. Operate the tilt control as described in “Machine Description - Controls” to adjust the drum attitude. This is especially important when lifting an open drum. The floor lock should be engaged while dispensing / draining.
6. When dispensing is complete, tilt drum back to upright position. Disengage the floor lock and lower the drum to transporting height; about 6” (15 cm) off the floor.



**WARNING - Stay Clear of Raised Drum** NEVER allow anyone to be below any part of a raised drum handler or drum. Remain behind the push handle while handling a drum.



**WARNING – Do NOT Disengage the Cinch Chain When Drum is off the Ground** When the drum is in the upright position, lower the drum to the floor before releasing the cinch chain.

7. Push the unit to the drum storage area and lower to the floor in an upright position. Release the cinch chain from the ratchet by applying pressure to the ratchet handle in a clockwise direction with one hand and opening the pawl to free the ratchet with the other hand. Remove the cinch chain link from the ratchet.

## Maintenance

- Periodic inspection for the general condition of structural and mechanical components is imperative for safe and efficient operation.
- Periodically inspect all moving parts, framework, and contact areas for signs of wear, fatigue, or loosening. Tighten, adjust, or replace parts as necessary to prevent failure and maintain proper function.
- Inspect the hydraulic system for oil drips, hose damage, or other signs of wear. Inspect the level and condition of the hydraulic fluid. Replace any parts that show signs of wear.
- Grease wheel bearings periodically. Oil or grease all moving parts including: the three clevis pins and the surfaces of the boom which contact the inside of the mast cap, the hinge pin, the gears and sprockets in the tilt drive, and the ratchet and pawl.
- Worn or damaged parts must be properly replaced with the correct, genuine Morse parts.
- Hydraulic pump is shipped filled with Noco Premium plus automatic transmission fluid d/m. Safety data sheet (SDS / MSDS) is available online. Change oil yearly, sooner depending on dirty conditions or outdoor use. Replace oil with Mobil dte 24 or equivalent for indoor use (Mobil dte 13 for outdoor use).