

CONTENTS

- Receiving Procedures
- Warranty
- Safety Information
- Machine Description
- Accessories
- Operating Instructions
- Maintenance



Receiving Procedures

Every Morse drum handler is inspected prior to shipping. However, damage may be incurred during transit.

- Check for visible damage. If you choose to accept damaged freight, always sign noting the damage on the **BILL OF LADING**.
- Document the damage and have the truck driver sign. We recommend keeping a digital camera at your receiving dock for this purpose.
- Open packages expeditiously to check the condition of the goods. There is only a 24 hour window to notify the carrier of any concealed damage.
- **IMMEDIATELY REPORT ALL DAMAGE TO THE SHIPPING COMPANY!** Then you may contact Morse for assistance with your freight claim.
- Morse Manufacturing will not be held responsible for any damaged freight that is not signed for as damaged.

Limited 2 Year Warranty

Morse drum handling equipment is guaranteed against defects in workmanship or materials for **TWO YEARS** when used properly within its rated capacity. Warranty does not cover wear from normal use or damage from accident or abuse. Motors and other purchased parts carry the warranties of their manufacturers.

For warranty claims, contact your Morse Dealer to obtain a return authorization number, and for return freight advice. Return freight must be prepaid.

In all instances, liability is limited to the purchase price paid or to repairing or replacing the product. Customer assumes liability for any modifications, unauthorized repairs or parts substitution.

Safety Information

While Morse Manufacturing Co. drum handling equipment is engineered for safety and efficiency, a high degree of responsibility must be placed upon the machine operator to follow safe practices, based primarily on common sense, upon which true safety depends.

Failure to follow the safety precautions in this manual can result in personal injury or property damage. Observe the same precautions as with similar machinery where carelessness in operating or maintenance is hazardous to personnel. Carefully read the safety precautions below and throughout this manual.

Review the Material Safety Data Sheet(s) for the material(s) in the drum(s) and take all necessary precautions. Safety shoes, work gloves, hard hat and other personal protective devices are recommended.

Prior to initial use, inspect all moving parts. Inspect saddle assembly for proper operation. Perform necessary load test, inspections, operator training, etc.













DANGER - Indicates a situation which, if not avoided, will result in serious injury or death. This signal word is limited to the most extreme situations.



WARNING - Indicates a situation which, if not avoided, could result in serious injury or death.



CAUTION - Indicates a situation which, if not avoided, can result in damage to the machine.

		<p>CAUTION – Do Not Transport with Drum Raised. Always lower the drum holder to lowest position before transporting.</p>
	<p>WARNING - The Mobile-Lifter / Palletizer is designed to handle one drum of the types listed in Machine Description. DO NOT attempt to handle any other type of drum or object. DO NOT exceed the weight capacity of 1000 Lb. (454 kg).</p>	
	<p>WARNING - Level Floors Only. For operation only on clean, level floors of suitable bearing capacity. Do not use on sloped surfaces, ramps, irregular or debris strewn floors.</p>	
	<p>WARNING - Do Not Modify the Unit. Under no circumstances should any modifications be made to the Morse machinery without factory authorization. Any modifications may void the warranty. This machine was designed to perform a specific job and alterations may result in injury to operator or machine.</p>	
	<p>WARNING - No Loose Fitting Clothing. Wear close-fitting clothing and safety equipment appropriate to the job. Loose fitting clothing may become caught on the machinery and cause severe personal injury.</p>	
	<p>WARNING - Hydraulic Fluid Under Pressure Can Be Hazardous Escaping hydraulic fluid under pressure can penetrate the skin, causing serious injury. Avoid the hazard by relieving pressure before disconnecting hydraulic lines. Keep hands and body away from pinholes and nozzles, which eject fluid under high pressure. Use a piece of cardboard to search for leaks. If an accident occurs, see a doctor immediately and inform them of the nature of the accident.</p>	
	<p>CAUTION - Wear safety shoes with non-slip soles and hard toe protection.</p>	
	<p>CAUTION - DO NOT allow drum to impact on floor, ground, or dumping station, etc.</p>	
	<p>WARNING - This product can expose you to chemicals including barium sulfate, cobalt, titanium dioxide, and 2-methylimidazole, which are known to the State of California to cause cancer, and bisphenol-A, which is known to the State of California to cause birth defects or other reproductive harm. For more information go to www.P65Warnings.ca.gov</p>	

Machine Description

The Mobile Lifter / Palletizer is designed to lift and transport rimmed drums of various diameters with a minimum drum height of 20" (508 m). Drum should weigh at least 75 Lb. (34 kg) to complete clamping action. The maximum capacity is 1000 Lb. (454 kg).

MORSE Mfg. Co., Inc. Syracuse, NY The Specialist in Drum Handling Equipment	1000 Lb. (454 kg) Max. Capacity	Made in U.S.A.
--	---	----------------

Installation Instructions

 **CAUTION**

- Hydraulic pump is shipped with a plug in the reservoir to prevent spillage in transit
- Prior to operation, replace the shipping plug with provided breather plug
- Failure to properly install breather plug will void manufacturer's Limited Warranty

Part # PLTAG-04

Controls

The Morse Mobile Lifter / Palletizer is manually propelled and steered.

LIFT and Lower Function

To raise the drum

1. Insert pump lever handle into pump socket.
2. With the release valve closed, begin to pump the lever handle.
The drum will lift.

To lower the drum

Open the release valve slowly, a part of a turn. Allow the drum to descend at a controlled rate. The valve may be reclosed to hold the drum at any height.

 **WARNING:** Keep hands and fingers clear of tilt lock hole, as a pinch point will occur when drum rotates.

 **WARNING:** Keep hands and other objects away from drum-gripping jaws.

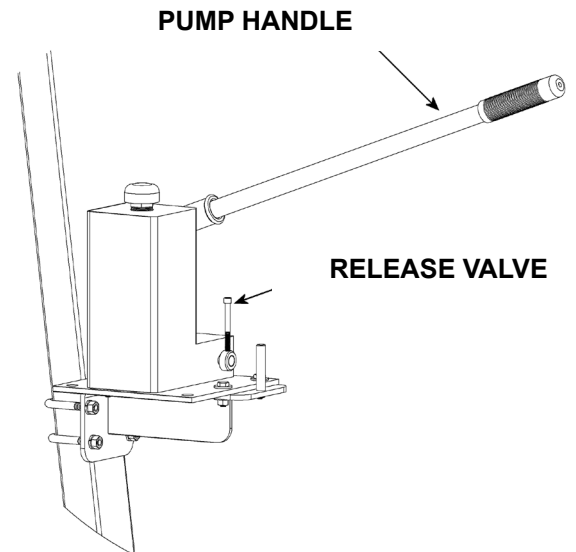

OPERATING INSTRUCTION

1. Roll drum lifter to drum. Steer unit so head and bottom support meet centerline of drum. Head should push into side of drum near drum top. Exact height is not critical. Jaws should arrive below drum rim. This usually corresponds to having top of head about as high as top of drum.

 **WARNING:** Keep hands and other objects away from top opening of lifting frame.

2. To clamp drum: Operate lift function to raise head while it is held against the drum. Drum-gripping action is automatic as the head rises. This is how it works: As the head rises, the lower jaw will come up under the lip of the drum rim, "catch" under it, and be held down. As the head rises with the lower jaw thus held by the drum rim, internal linkage will pull the upper jaw downward to meet the top of the drum rim. The drum's weight on the lower jaw creates the force that pulls the upper jaw down to tightly grip the drum rim. No manual contact is required.

 **WARNING:** Keep hands and other objects away from drum-gripping jaws.

3. With drum held off the floor, push drum lifter to deliver drum. Avoid unreasonably rough or non-level surfaces. Move at moderate speed. Carry drum only high enough to avoid contact with the floor or obstacles. Push loaded unit when possible for transporting. Pulling unit should be limited to maneuvering at short distance.

 **WARNING:** Excessive pitching or bouncing caused by rushing over rough or non-level floors can make drum momentarily weightless, jaws can disengage.

4. To release drum at intended destination: operate control to lower drum onto level floor or pallet. When drum comes to rest and head continues to lower, weight will no longer be on the lower jaw and jaws will open automatically. No manual contact is required. Do not stop lowering as soon as drum touches down, keep going down for a few more inches. Pull unit away once upper jaw has retracted clear of drum rim. Park unit on level floor, out of traffic lanes when not in use.

5. Adjustment for Shorter Drums: The head is factory set in upper position for handling drums at least 34" (86.4 cm) tall, including typical 55-gallon (210L) drums. For handling drums as short as 22" (56 cm), relocate head downward as follows: Detach head by removing nuts that hold head to lifting assembly. Reattach head at alternate location 12" (30.5 cm) lower.

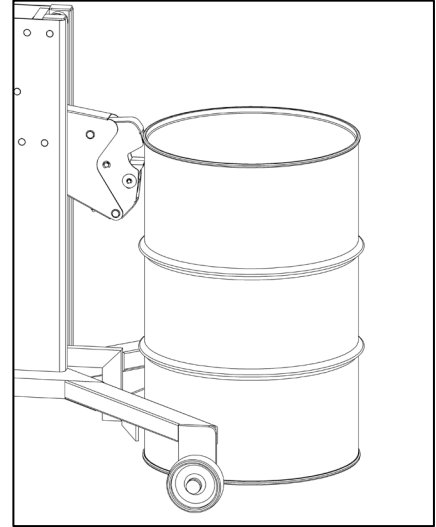

Maintenance

- Periodic inspection for the general condition of structural and mechanical components is imperative for safe and efficient operation.
- Periodically inspect all moving parts, framework, and contact areas for signs of wear, fatigue, or loosening. Tighten, adjust, or replace parts as necessary to prevent failure and maintain proper function.
- Inspect the hydraulic system for oil drips, hose damage, or other signs of wear. Inspect the level and condition of the hydraulic fluid. Replace any parts that show signs of wear.
- Grease wheel bearings periodically. Clean and lubricate all moving parts including: Cylinder pin and linkages.
- Worn or damaged parts must be properly replaced with the correct, genuine Morse parts.
- Hydraulic pump is shipped filled with Noco Premium plus automatic transmission fluid d/m. Safety data sheet (SDS / MSDS) is available online. Change oil yearly, sooner depending on dirty conditions or outdoor use. Replace oil with Mobil dte 24 or equivalent for indoor use (Mobil dte 13 for outdoor use).