

Parts Diagram for Part # 5305-P
Overhead Assembly for Morse 82A Series Mobile-Karrier / Palletizer
Serial Number 0313 to 1014 (MMYY)

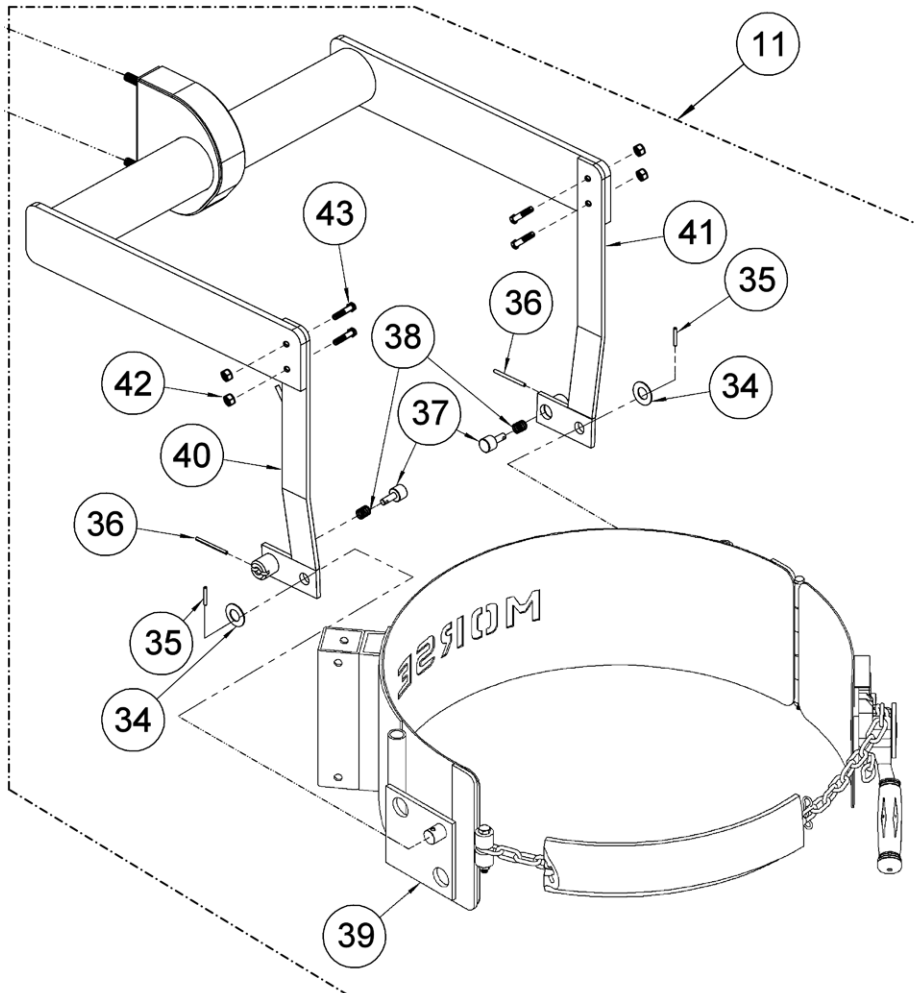

ITEM	QTY.	PART #	DESCRIPTION
11	1	5305-P	OVERHEAD ASM, 82A
34	2	62-P	WASHER, 3/4 SPRING
35	2	64-P	ROLL PIN, 3/16 X 1-1/4
36	2	61-P	ROLL PIN, 3/16 X 2-1/2
37	2	59-P	PLUNGER, 80, 85
38	2	60-P	SPRING, PLUNGER, 80, 85
39	1	101Z-P	SADDLE, 80 82 85 SOCKET TUBE
40	1	5316CPT-P	LINK ASM, LEFT, 82A, GT
41	1	5317CPT-P	LINK ASM, RIGHT, 82A, GT
42	4	810-P	NUT, 1/2-13 REV HEX LOCK
43	4	805-P	BOLT, 1/2-13 X 1-1/4 CARRIAGE
* Recommended spare parts.			