

## CONTENTS

- Receiving Procedures
- Warranty
- Safety Information
- Machine Description
- Operating Instructions
- Maintenance
- Dimensions to Calculate Lost Load

### Receiving Procedures

Every Morse drum handler is inspected prior to shipping. However, damage may be incurred during transit.

- Check for visible damage. If you choose to accept damaged freight, always sign noting the damage on the **BILL OF LADING**.
- Document the damage and have the truck driver sign. We recommend keeping a digital camera at your receiving dock for this purpose.
- Open packages expeditiously to check the condition of the goods. There is only a 24 hour window to notify the carrier of any concealed damage.
- **IMMEDIATELY REPORT ALL DAMAGE TO THE SHIPPING COMPANY!** Then you may contact Morse for assistance with your freight claim.
- Morse Manufacturing will not be held responsible for any damaged freight that is not signed for as damaged.

Delivery to non-business addresses without a loading dock result in additional freight charges. Residential delivery fees, inside delivery fees, re-delivery charges, and lift gate services will be added by the truck line, and are non-negotiable.

### Limited 2 Year Warranty

Morse drum handling equipment is guaranteed against defects in workmanship or materials for **TWO YEARS** when used properly within its rated capacity. Warranty does not cover wear from normal use or damage from accident or abuse. Motors and other purchased parts carry the warranties of their manufacturers.



For warranty claims, contact your Morse Dealer to obtain a return authorization number, and for return freight advice. Return freight must be prepaid.

In all instances, liability is limited to the purchase price paid or to repairing or replacing the product. Customer assumes liability for any modifications, unauthorized repairs or parts substitution.

### Safety Information

While Morse Manufacturing Co. drum handling equipment is engineered for safety and efficiency, a high degree of responsibility must be placed upon the machine operator to follow safe practices, based primarily on common sense, upon which true safety depends.

Failure to follow the safety precautions in this manual can result in personal injury or property damage. Observe the same precautions as with similar machinery where carelessness in operating or maintenance is hazardous to personnel. Carefully read the safety precautions below and throughout this manual.

Review the Material Safety Data Sheet(s) for the material(s) in the drum(s) and take all necessary precautions. Safety shoes, work gloves, hard hat and other personal protective devices are recommended.

Prior to initial use, inspect all moving parts and test rotation of drum holder. Perform necessary load test, inspections, operator training, etc.











**DANGER** - Indicates a situation which, if not avoided, will result in serious injury or death. This signal word is limited to the most extreme situations.



**WARNING** - Indicates a situation which, if not avoided, could result in serious injury or death.



**CAUTION** - Indicates a situation which, if not avoided, can result in damage to the machine.

 	<p><b>CAUTION</b> – Do Not Transport with Drum Raised. Always lower the drum holder to lowest position before transporting.</p>
	<p><b>WARNING</b> - The Forklift-Karrier is designed to handle one drum of the types listed in Machine Description. DO NOT attempt to handle any other type of drum or object. DO NOT exceed the weight capacity of 1500 Lb. (680 kg). Exceeding these ratings is unsafe and could result in equipment damage, excessive wear or awkward handling.</p>
	<p><b>WARNING</b> - Do Not Modify the Unit. Under no circumstances should any modifications be made to the Morse machinery without factory authorization. Any modifications may void the warranty. This machine was designed to perform a specific job and alterations may result in injury to operator or machine.</p>
	<p><b>WARNING</b> - No Loose Fitting Clothing. Wear close-fitting clothing and safety equipment appropriate to the job. Loose fitting clothing may become caught on the machinery and cause severe personal injury.</p>
	<p><b>CAUTION</b> - Wear safety shoes with non-slip soles and hard toe protection.</p>
	<p><b>CAUTION</b> - DO NOT allow drum to impact on floor, ground, or dumping station, etc.</p>
	<p><b>WARNING</b> - This product can expose you to chemicals including barium sulfate, cobalt, titanium dioxide, and 2-methylimidazole, which are known to the State of California to cause cancer, and bisphenol-A, which is known to the State of California to cause birth defects or other reproductive harm. For more information go to <a href="http://www.P65Warnings.ca.gov">www.P65Warnings.ca.gov</a></p>
	<p><b>WARNING</b> - This product can expose you to chemicals including lead and arsenic, which are known to the State of California to cause cancer and birth defects or other reproductive harm. For more information go to <a href="http://www.P65Warnings.ca.gov">www.P65Warnings.ca.gov</a></p>

### Machine Description

Model 285A-BP Forklift-Karrier is designed to lift, transport, and dispense a ribbed 55-gallon (210 liter) steel or fiber drum 22.5" to 23.5" (56 to 59.7 cm) in diameter.

The maximum full-drum capacity is 1500 Lb. (680 kg). The capacity is derated to 800 Lb. (363 kg) for a half-full drum. The half-full rating is based on the tilt mechanism's capacity for handling an unbalanced, bottom-heavy drum.



### Important

1. Please read all instructions thoroughly before attempting to operate your new Morse drum handler.
2. When loading, unloading, operating, or maintaining your MORSE drum handler, always use care and good judgment. Maintain secure footing and a firm hold. Keep hands and loose clothing away from all moving parts. Never allow anyone to be below any part of a raised drum handler or drum. Read operating instructions and review the pictures in the sales brochure before operation.
3. This model is a front-end attachment for a forklift, OSHA recommends that "... the truck (forklift) be marked to identify the attachment(s) and show the approximate weight of the truck and attachment combination at maximum elevation with load laterally centered." See center of gravity dimensions for calculating lost load on your equipment.
4. **IMPORTANT:** Prior to operation, open rear cover to access power pack and replace the **RED** shipping plug in hydraulic reservoir with supplied **BLACK** breather plug.

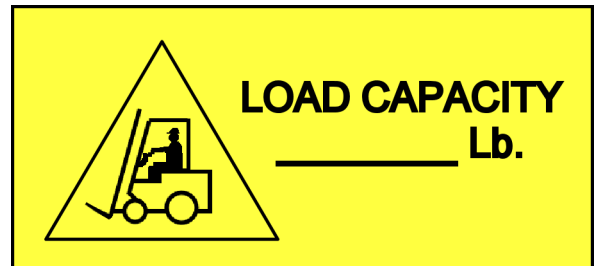

## Operating Instructions

1. Before sliding forklift forks into the fork tubes, adjust forks to an inside spread of 25" (63.5 cm) minimum. Lock forks into position on the forklift carriage.
2. Drive the forklift forward to slip the forks into the fork tubes. Tighten tee screws to secure the Forklift Karrier to the forks.
3. Release the cinch chain and hang the loose end from the upright peg on the front of the guard. Allow the ratchet hinge plate to swing to the open position.
4. Drive the forklift with the Forklift Karrier near floor level to position the saddle band around the middle of the drum between the ribs.
5. Drape the cinch chain across the front of the drum and insert one link into the slot on the ratchet handle. Turn the ratchet handle clockwise to tighten the cinch chain around the drum (shown right).
6. Remove pendant assembly from holder on guard and place near operator's seat.
7. Raise forks to clear the floor and transport drum in vertical position to dispensing location.
8. To pour drum: press the down button on the pendant, rotating drum to angle required for dispensing.
9. When dispensing is completed, rotate the drum back to vertical by pressing the up button on the pendant and return drum. While transporting, ensure that the drum is raised away from the floor to prevent the drum bottom from interfering with a pallet or other obstacle.

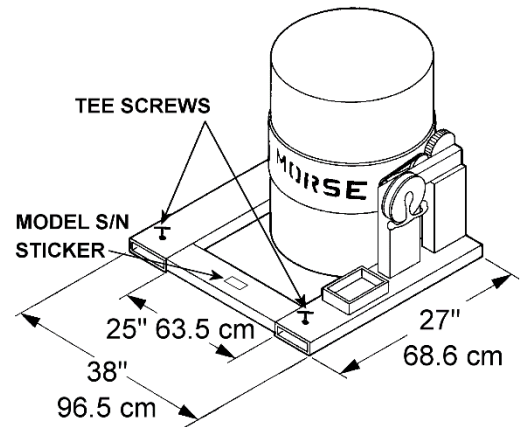

## Maintenance

1. Lubricate cylinder pins and linkages.
2. Clean and oil ratchet, pawl, saddle hinge, and other moving parts periodically. Clean & lubricate more often in environments where dust, dirt or other foreign particles will effect the performance of moving parts.
3. Periodic inspection for general condition of structural and mechanical components is imperative for safe and efficient operation.
4. Periodically inspect all moving parts, framework, and contact areas for signs of wear, fatigue, or loosening. Tighten, adjust, or replace parts as necessary to prevent failure and maintain proper function.
5. Inspect hydraulic system for oil drips, hose damage, or other signs of wear. Inspect level and condition of hydraulic fluid. Replace any parts that show signs of wear.
6. Worn or damaged parts must be properly replaced with the correct, genuine Morse parts.
7. Hydraulic pump is shipped filled with Noco Premium plus automatic transmission fluid d/m. Safety data sheet (SDS) is available online. Change oil yearly, sooner depending on dirty conditions or outdoor use. Replace oil with Mobil dte 24 or equivalent for indoor use (Mobil dte 13 for outdoor use).

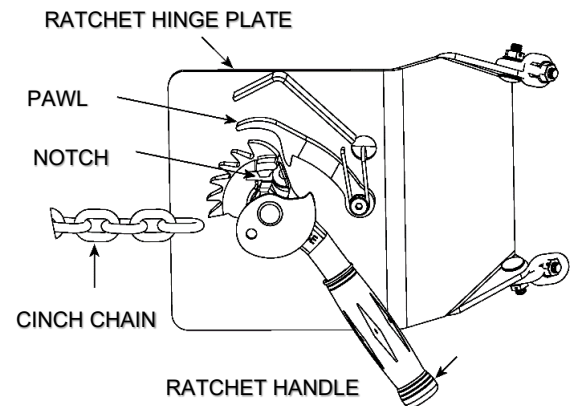

### Dimensions to Calculate Lost Load

- MAXIMUM LOAD: 1500 Lb. (680 kg)
- UNIT NET WEIGHT: 326 Lb. (148 kg)

